

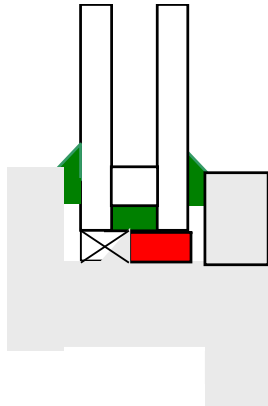

REVOLUTION WITHOUT FRAMES



Historie und Entwicklung des Holz-Glas-Verbundsystems (HGV)



Innovative Holz/Glasklebung

© hanspeter petschenig 13 03 2015 – Bauzentrum München

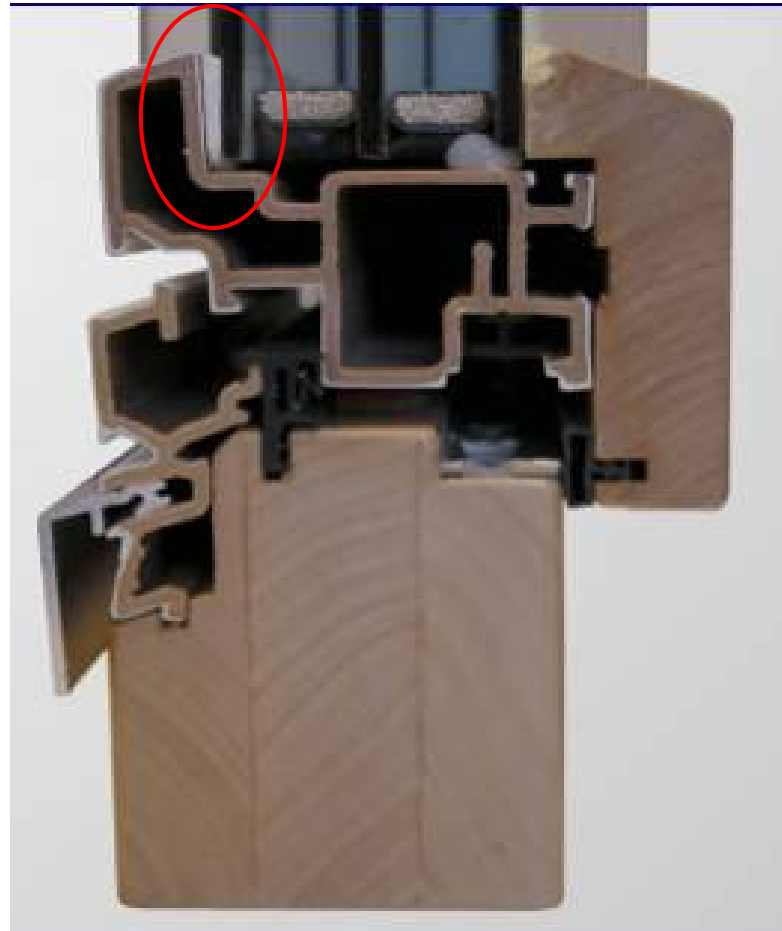
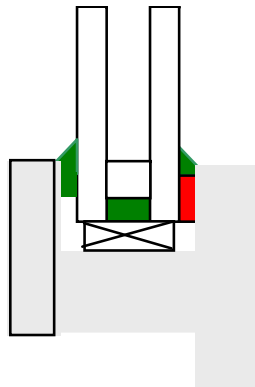
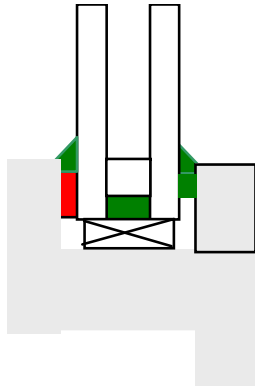

Innovative Holz/Glasklebung

© hanspeter petschenig 13 03 2015 – Bauzentrum München

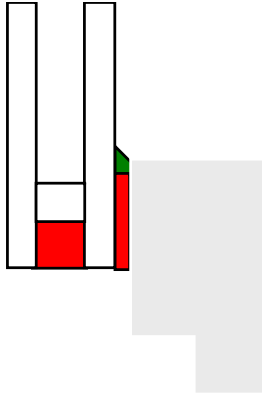

Innovative Holz/Glasklebung

© hanspeter petschenig 13 03 2015 – Bauzentrum München

UNIGLAS® | **FACADE**
Holz-Glas-Verbundelement



Petschenig®
glassteck



**OTTO
CHEMIE**
Dichtstoffe • Klebstoffe

Innovative Holz/Glasklebung

© hanspeter petschenig 13 03 2015 – Bauzentrum München

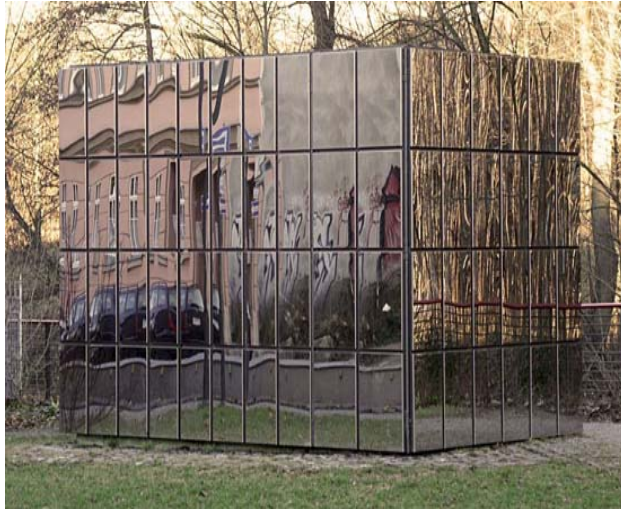

Fassade
ETAG 002

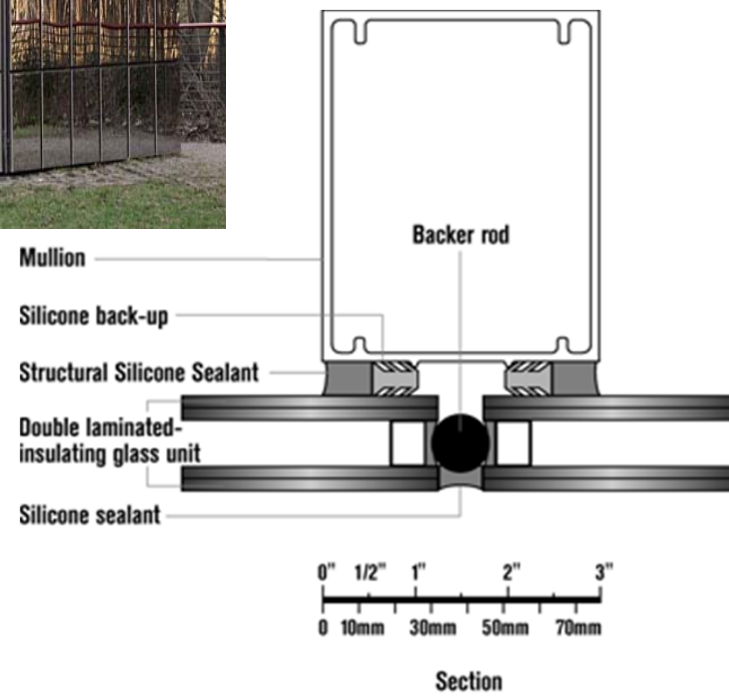

Fenster



Projektschritte

- Analyse von Konstruktionssystemen - Koppelleiste

P1

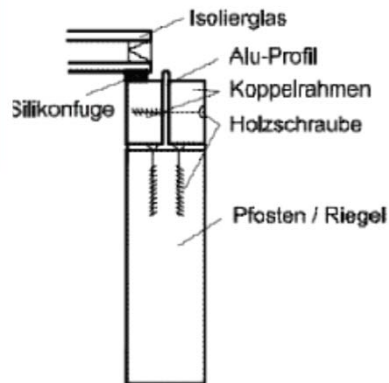

P2

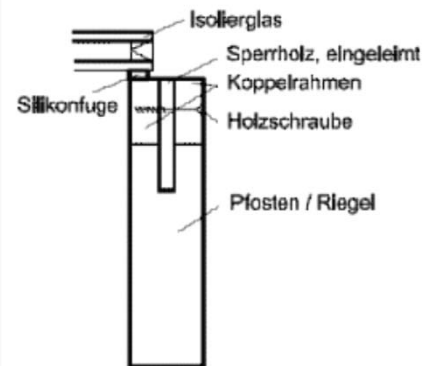

P3

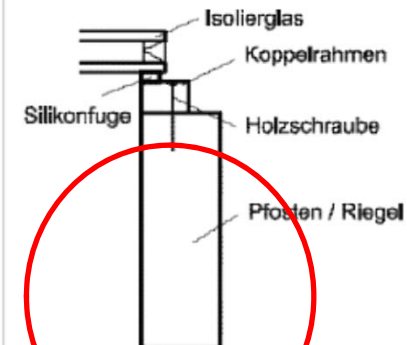

P5

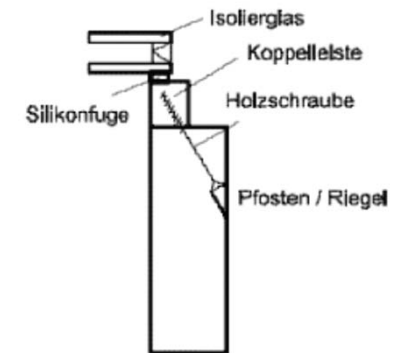



➤ **Projekt HGV-Elemente am i.f.t.**

2001-2002 mit Dipl.Ing. Peter Niedermaier

➤ **HGV 1 Grundprinzip**

2002-2005 Thomas EDL, HFA

➤ **Glas Kleben Klebesysteme**

2005-2008 Karin HAUER, HFA

➤ **HGV 2 Leistungsfähigkeit**

2006-2008 Georg NEUBAUER, HFA

➤ **HGV 3 Bemessungsmodell**

2008-2011 Werner HOCHHAUSER, TU Wien

➤ **HGV 4 Langzeitverhalten**

2011-2014 Wolfgang WINTER, TU Wien





punktueler Lasteintrag durch **Klotzung**

Spannungsspitzen
im Glas

konzentrierter Kraftfluss
durch die Scheibe

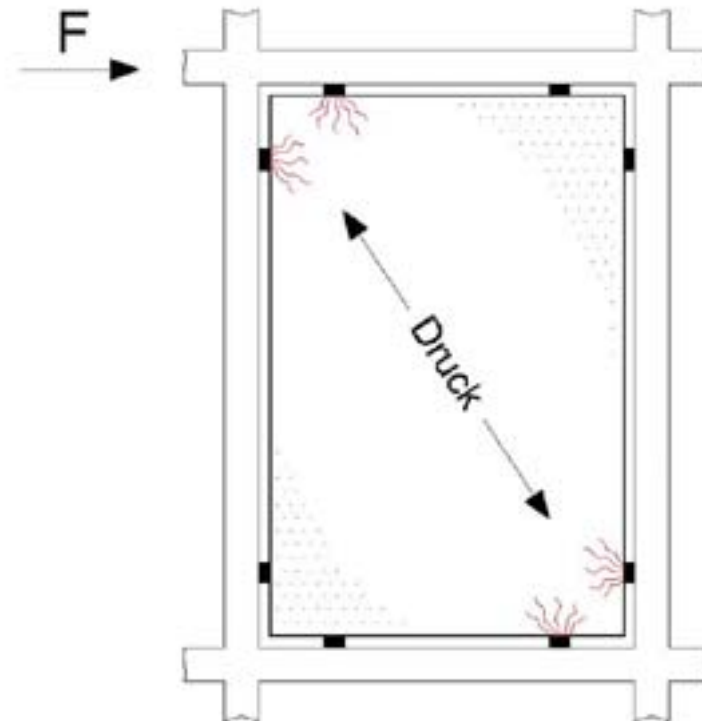



Eigengewicht

Winddruck (Beben)

Windsog (Beben)

Vertikallasten

Schiefstellung

Klimalasten

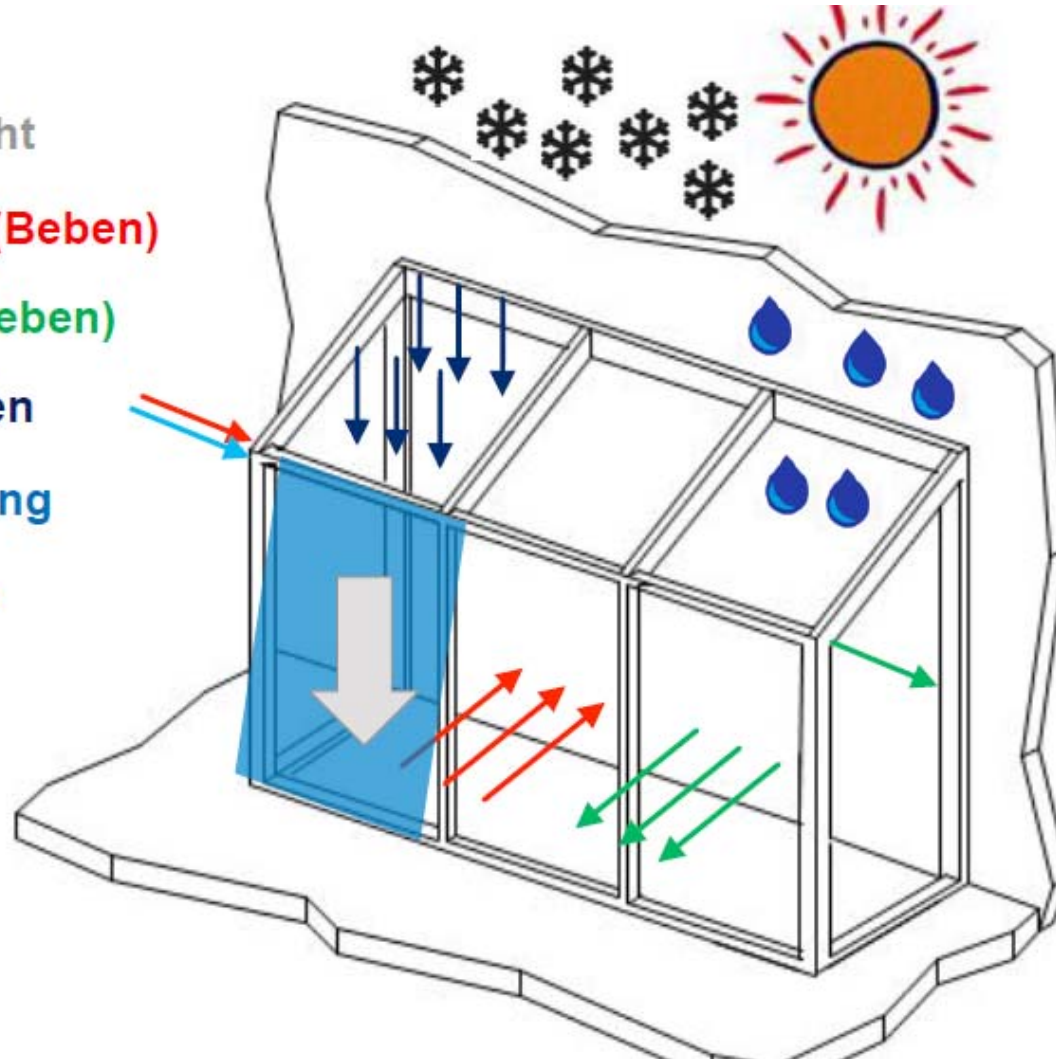

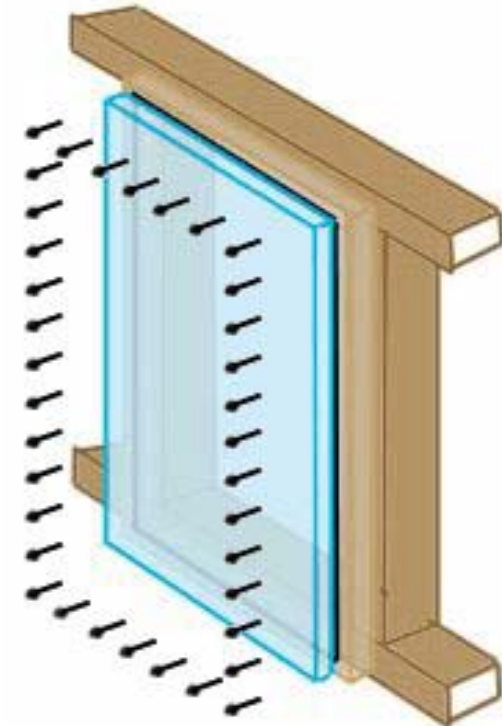
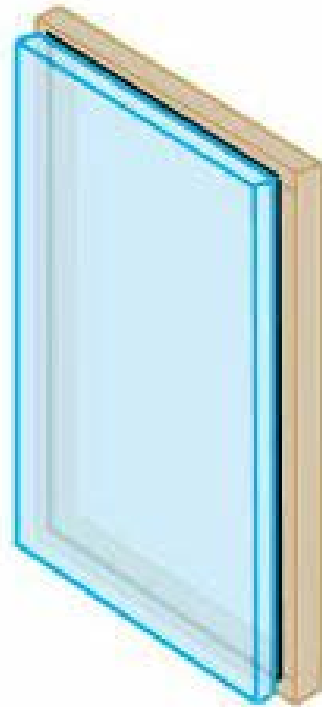
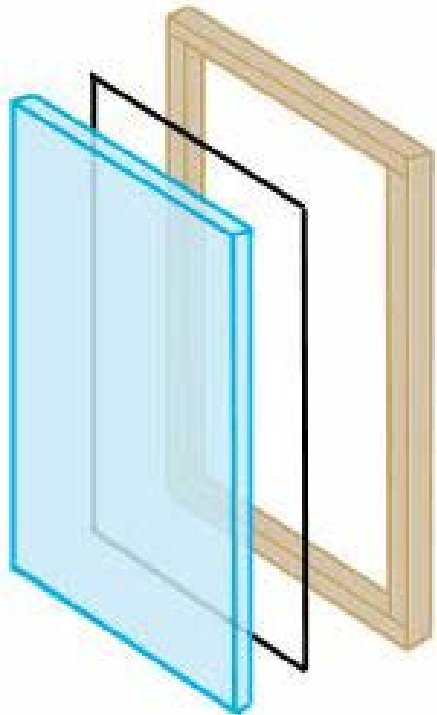

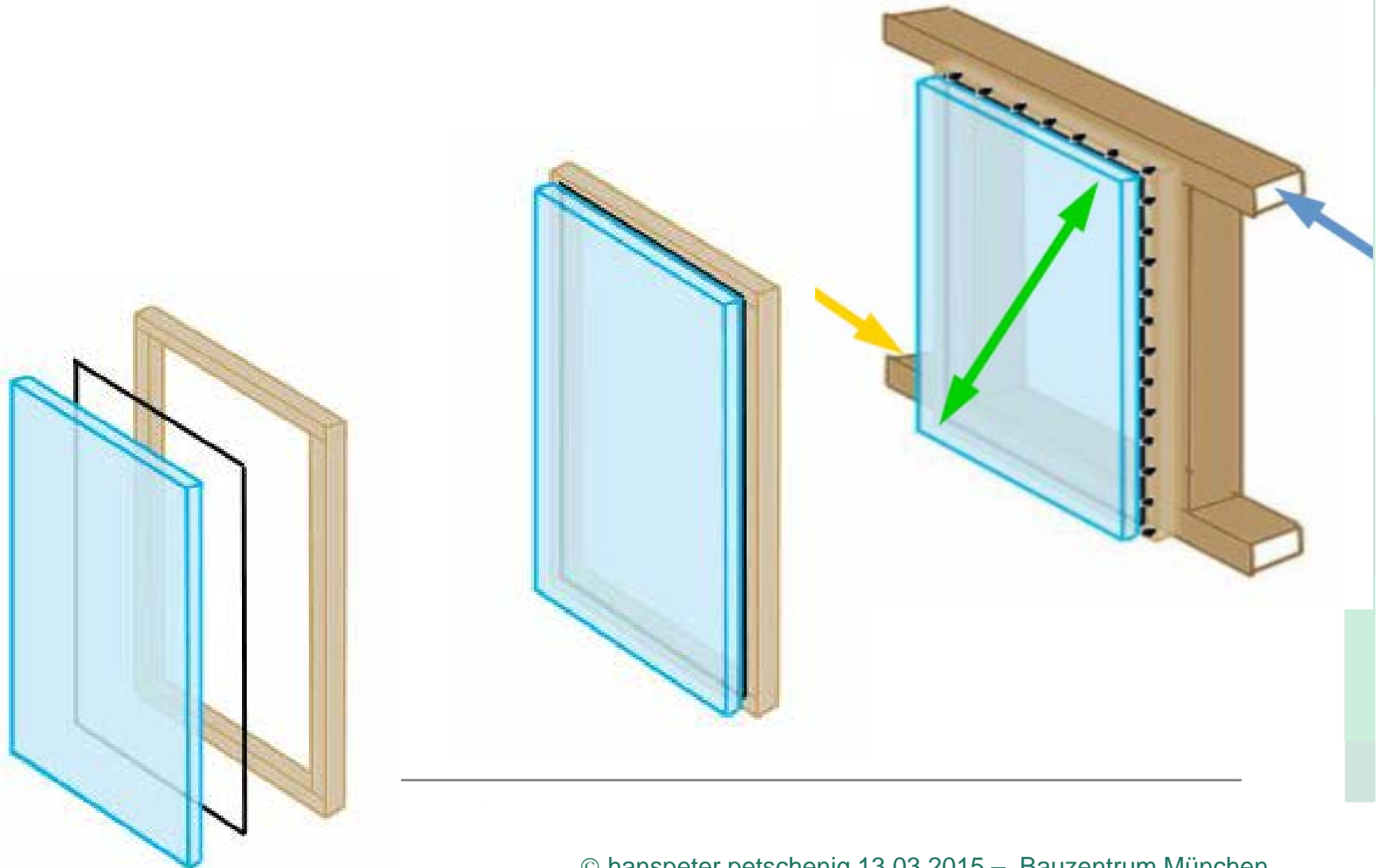

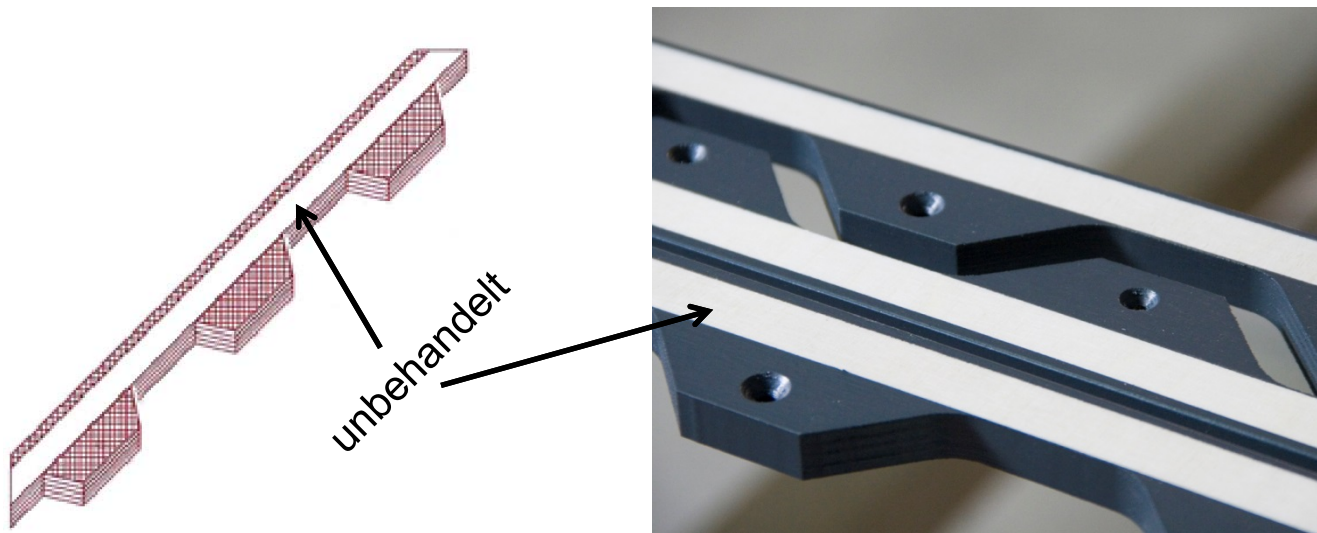

Oberflächenbeschichtung allseitig
nach Zuschnitt der Gehrungen

Klebebereich unbehandelt lassen

UNI GLAS® | **FACADE**
Timber-Glass-Composites



Petschenig®
glassteer

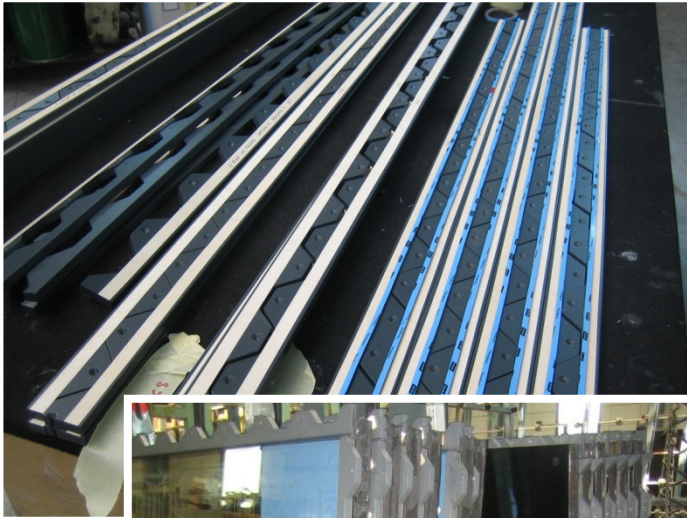

©

zentrum München

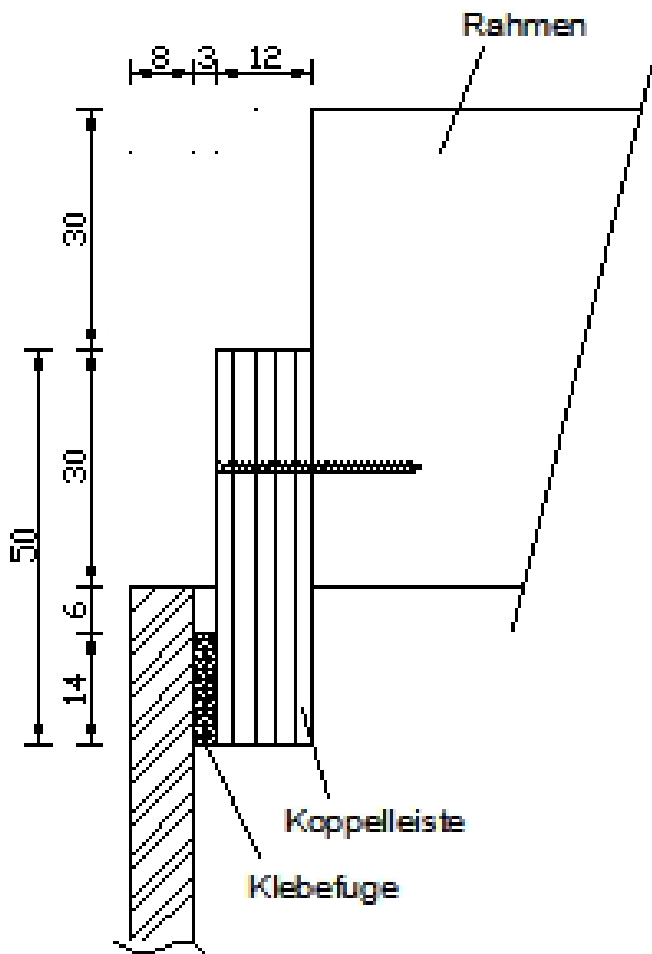

Koppelrahmen Holzforschung Austria
seitliche Schubverklebung



Bauteil

Ermittlung der statischen Leistungsfähigkeit

Einflussfaktoren an 18 Bauteiluntersuchungen:

- **Bauteilgeometrie**

- Geometrie h:l (1,25:2,5 – 2,5:1,25 m)

- **Klebstoff**

- Geometrie d:b (2:19 – 6:12 mm)
- Klebstoffart Silikon

Messergebnisse:

- Verschiebungen in Klebstoffebene (lokal)
- Verschiebungen am Element (global)
- Bruchlast des Elements

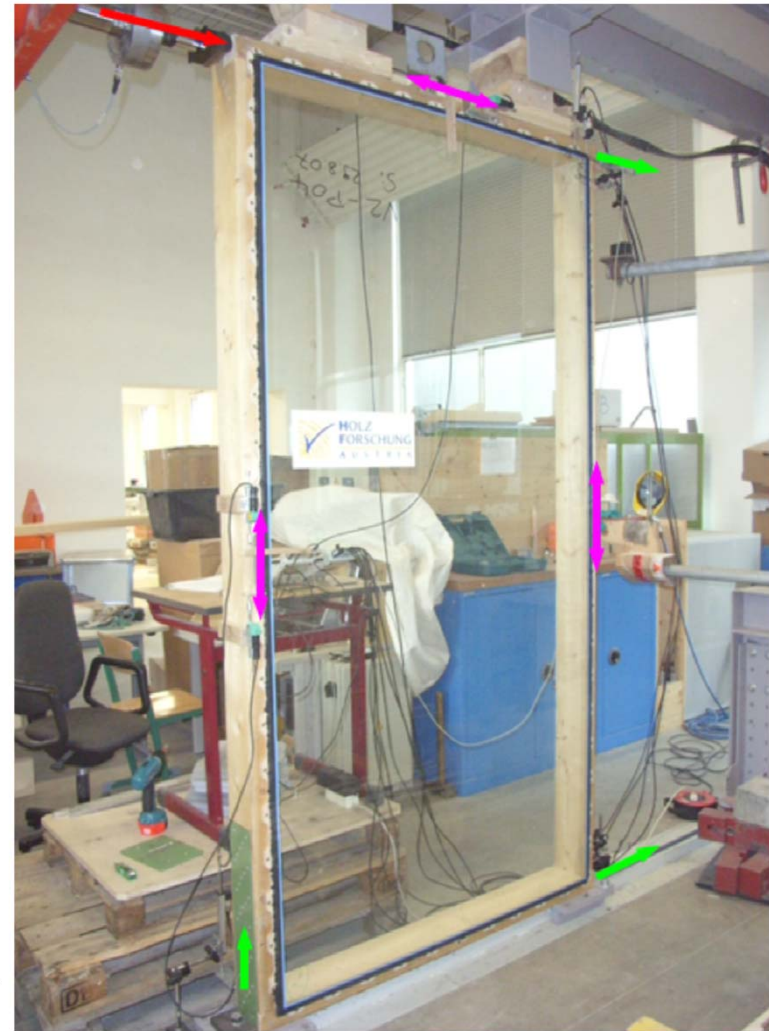



Untersuchungen am Bauteil

Referenzversuche 1,25 x 2,50 m - Silikon

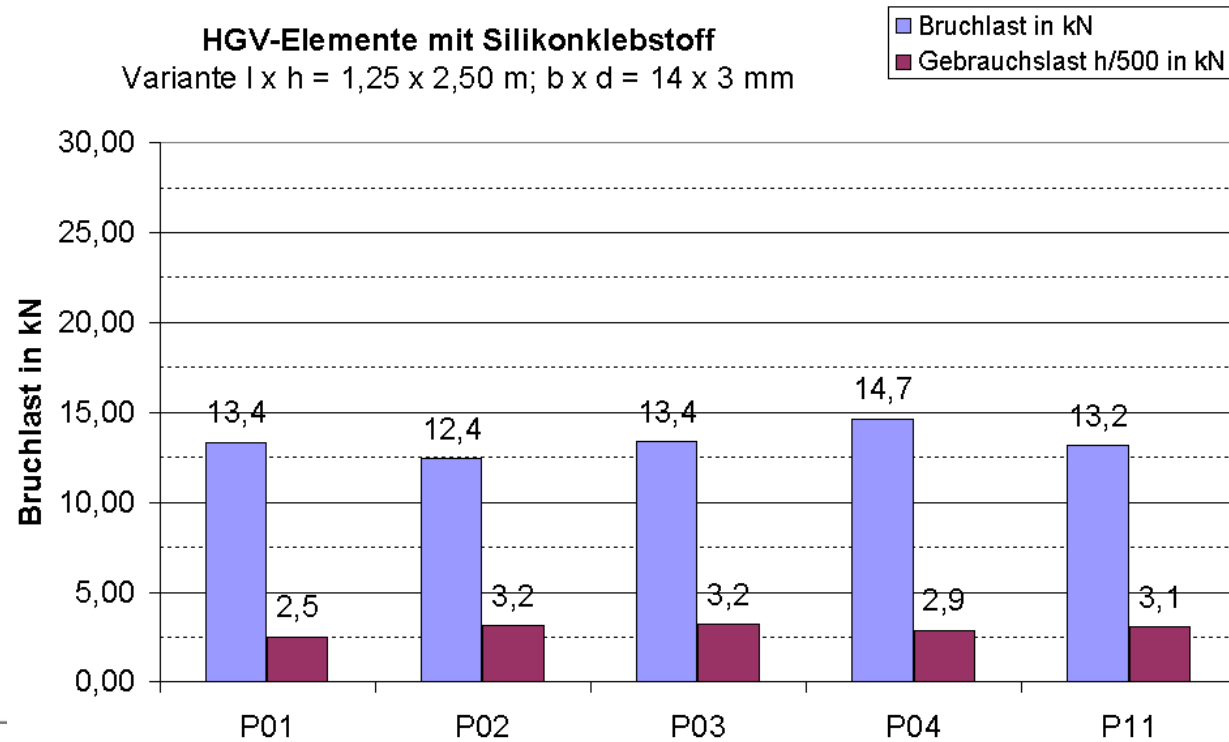



Ergebnisse:

HGV-Elemente Silikon:

- Sehr geringe Streuung bei Verformungen und Bruchlast
- Bis zu 22,5 kN Bruchlast
- Kopfverschiebung 1 mm / kN
- Ausschließlich Kohäsionsbruch im Klebstoff

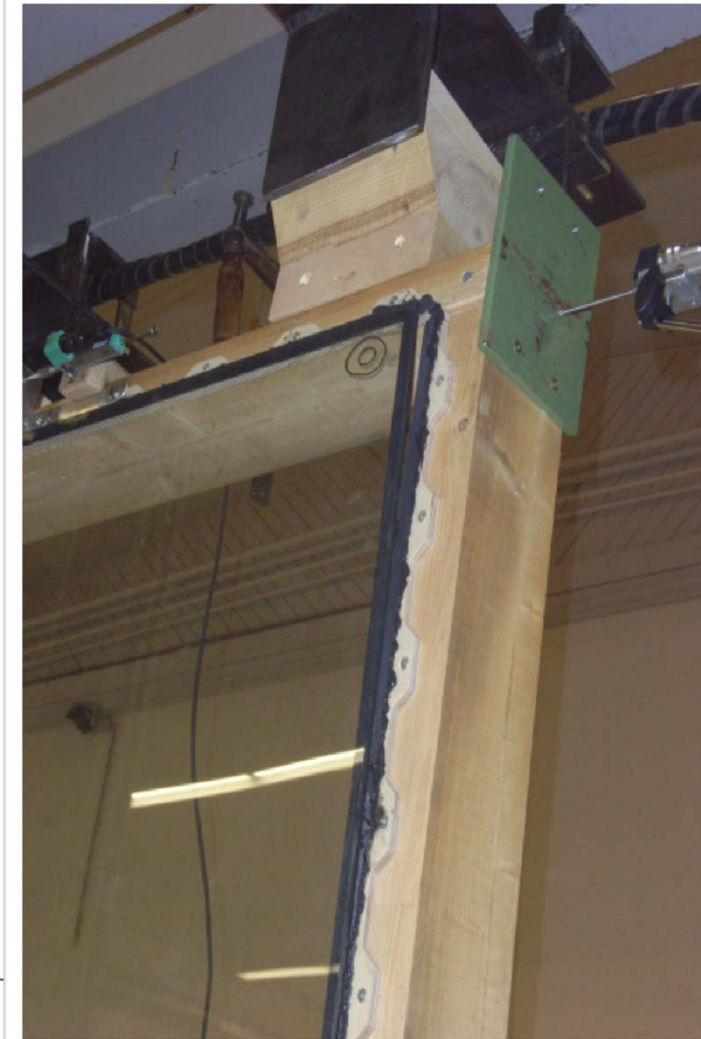
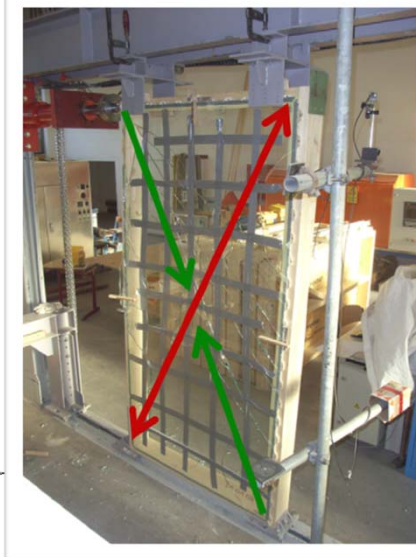

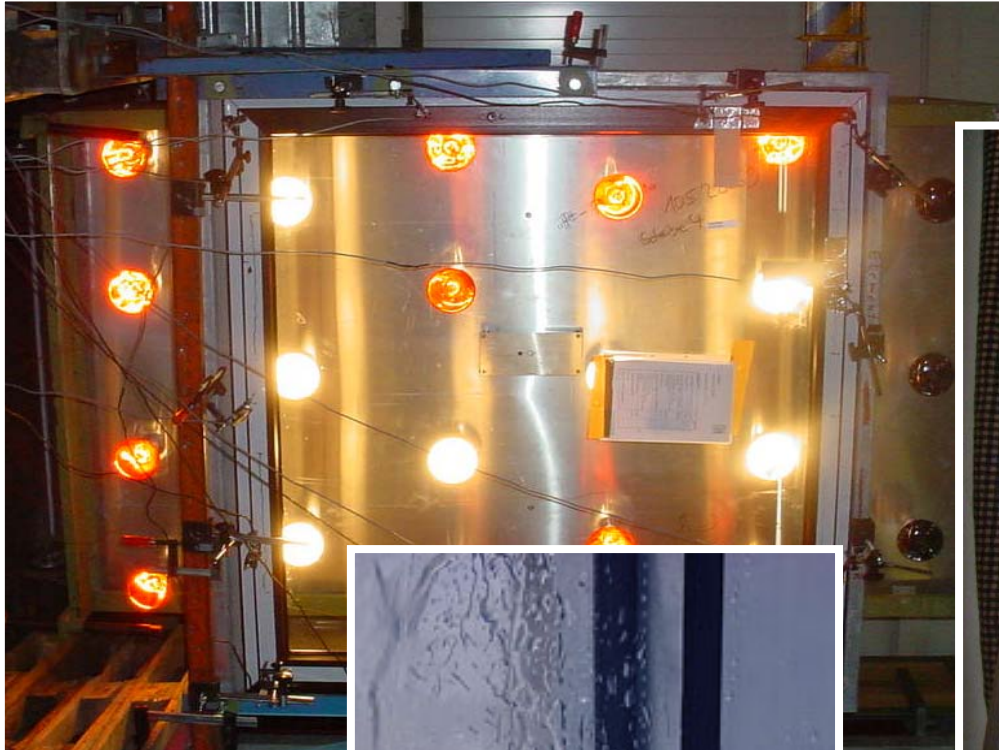

UV-Licht

Schnee

Temperatur

Regen





Untersuchung an **vier** unterschiedlichen Fassadenprototypen zur Quantifizierung der Leistungsfähigkeit der einzelnen Komponenten auf

- Schlagregendichtheit
EN 12154, EN 12155
- Luftdichtheit
EN 12152, EN 12153
- Windwiderstand
EN 12179
- Differenzklima / Kondensat



Ziel:
Funktionierendes
Fassadensystem zur
Erfüllung der dauerhaften
Funktion des Tragwerks
und als Witterungsschutz
des Gebäudes.



Prototyp 2
Differenzklimabeanspruchung:
Drei Differenzklimaphasen
Messung der Holzfeuchtigkeiten

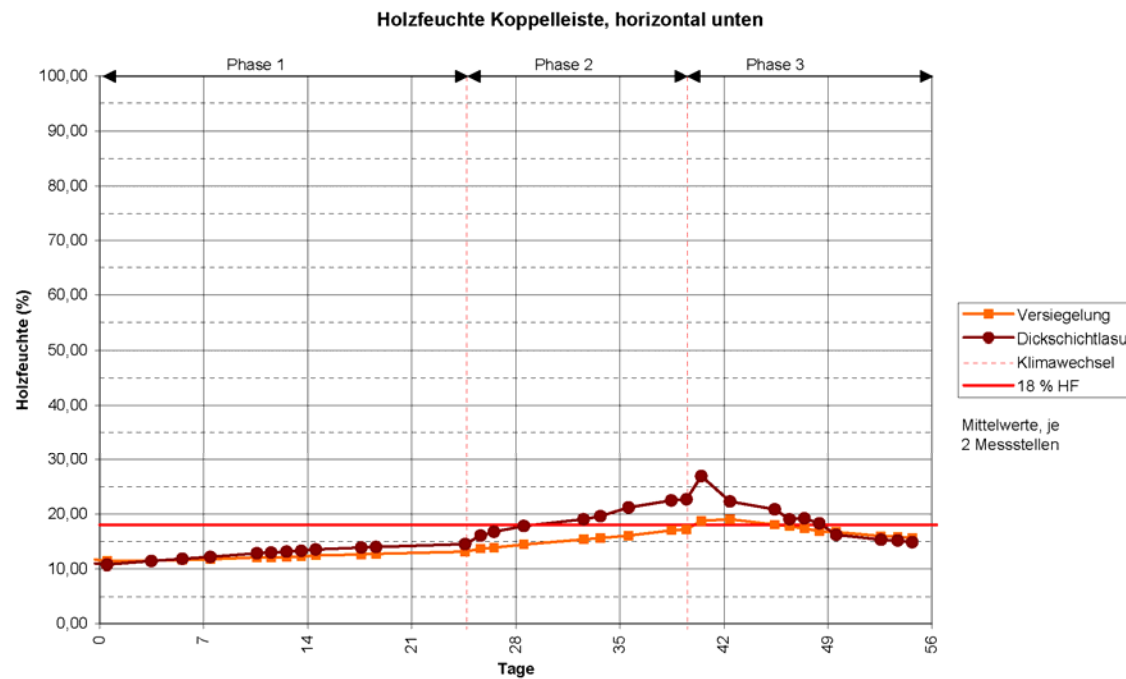



Prototyp 4 – Forschungsgebäude

- Temperaturverlauf Klebefuge

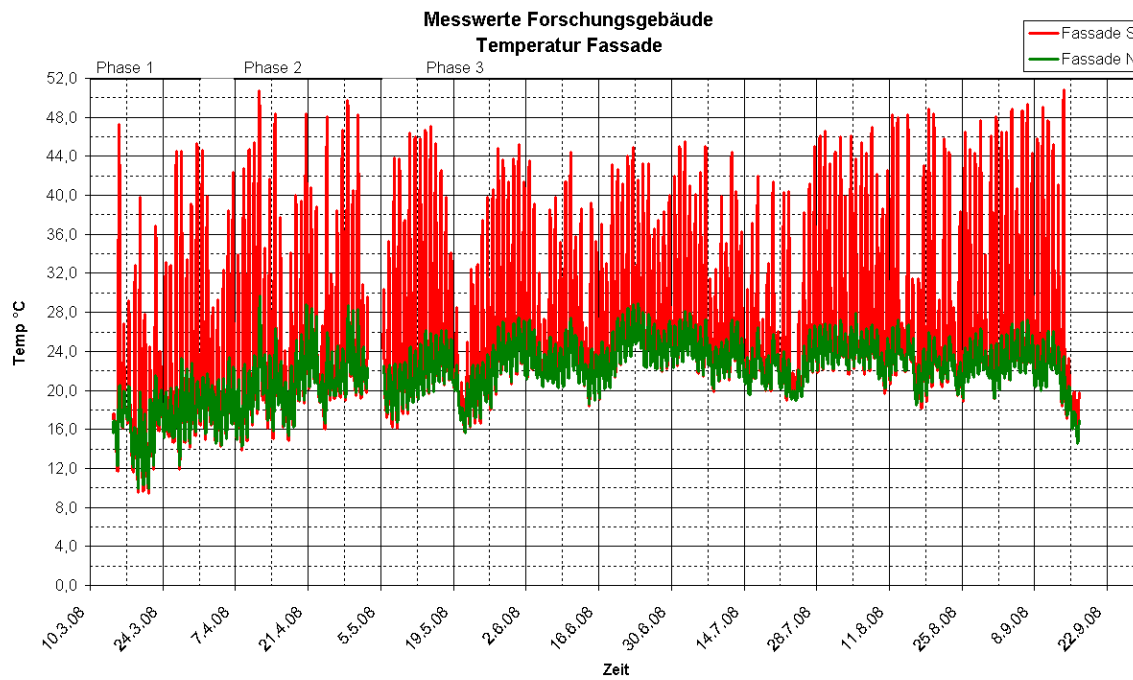

max S: +51 °C
max N: +30 °C



Leistungsfähigkeit der Klebstofffuge

Untersuchte Einflussfaktoren an 539 Probekörpern:

Klebefuge

- Geometrie d:b (2:19 – 6:12 mm)
- Klebstoffart Silikon

Bauphysik

- Temperatur (20 °C / 55 °C)
- Feuchtigkeit (3 Wo. H₂O)

Lasteinwirkungsdauer

- Kurzfristige Lasten
- Zyklische Lasten (5350 Zykl.)
- Dauerlasten (3 Mo.)

Belastungsrichtung

- Zugkräfte
- Schubkräfte
(längs und quer zur Fuge)

Z

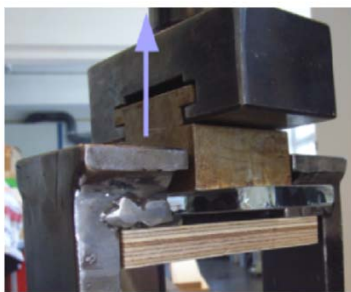

SL



SQ

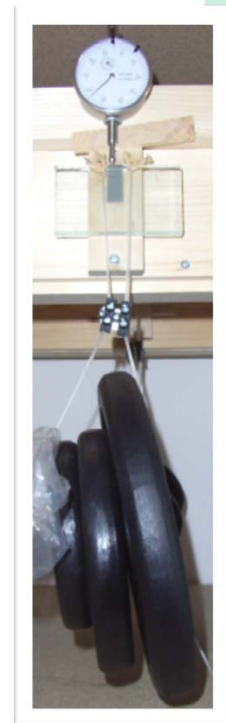
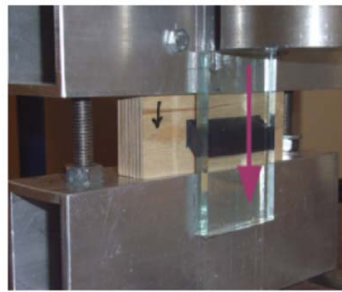



Statik

- Kriechverhalten unter Dauerlast

Dauer einer Untersuchung 90 Tage;

3 Klebstoffe

2 Belastungsrichtungen (SL, SQ)

Zwei Temperaturniveaus 20 °C / 55 °C

Unterschiedliche Dauerspannungsniveaus

Σ 206 Einzelprüfungen à 90 Tage

Forschungsprojekt Wood Wisdom 2012-2014

Σ 225 Einzelprüfungen à 365 Tage

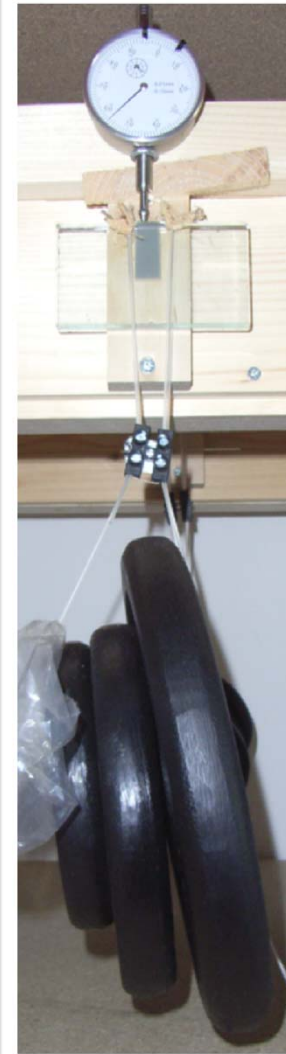



Statik

- Kriechverhalten unter Dauerlast

Dauerschubspannungen bis 0,04 N/mm² möglich

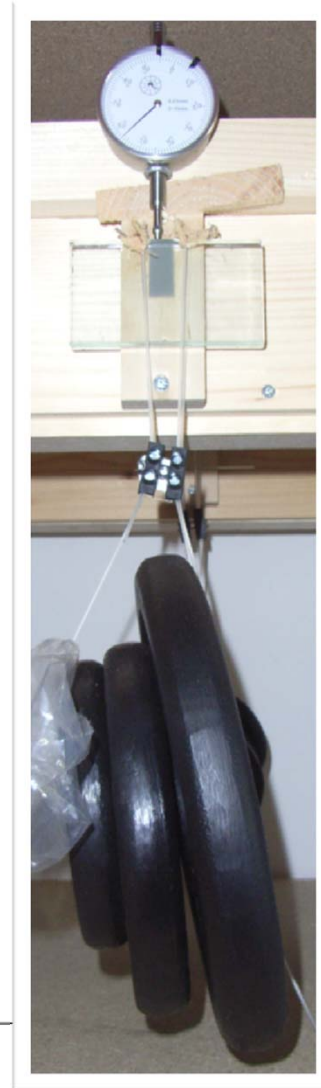
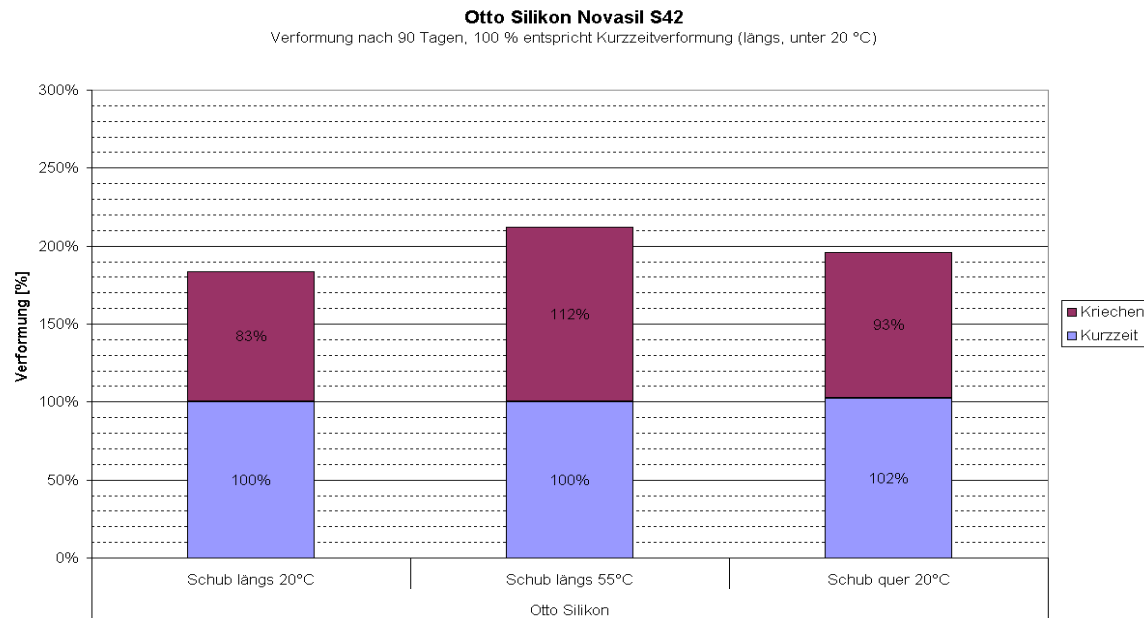



Leistungsfähigkeit der Klebstofffuge

Ergebnisse:

Silikonklebstoff:

- Grundfestigkeit /-steifigkeit geringer ($t=1,0 \text{ N/mm}^2$; $G=0,5 \text{ N/mm}^2$)
- Keine markanten Festigkeits- oder Steifigkeitsveränderungen
- Leichte Erhöhung der Steifigkeit bei wiederkehrender Belastung



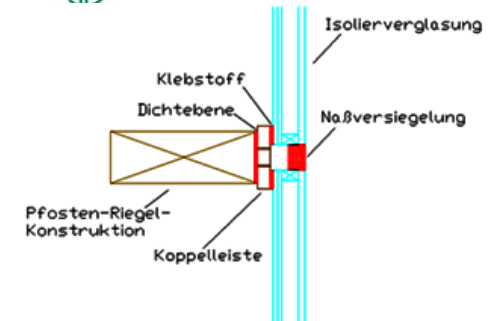

- Optimierung der verschiedenen Fassadenkomponenten (Kompribänder, Dichtebenen, optimierte Wasserableitung):

Anforderungen der EN an Fassaden in den höchsten Klassifizierungsklassen erfüllt!

- Kondensat an der Rauminnenseite entsteht im Zuge der Nutzung. Rücktrocknung des Holz und Klebstoffsubstrates über den Jahreszyklus muss gewährleistet sein (gute Isolierglasqualitäten oder Anordnung der Wärmequellen im Gebäude mit konzipieren)

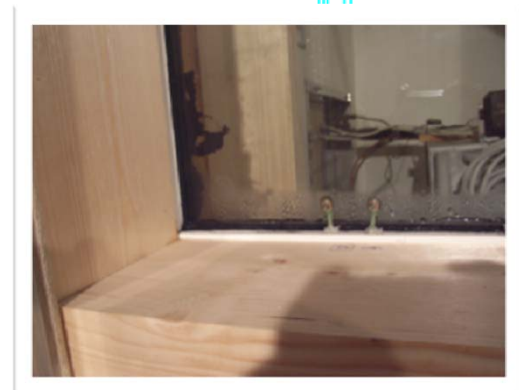

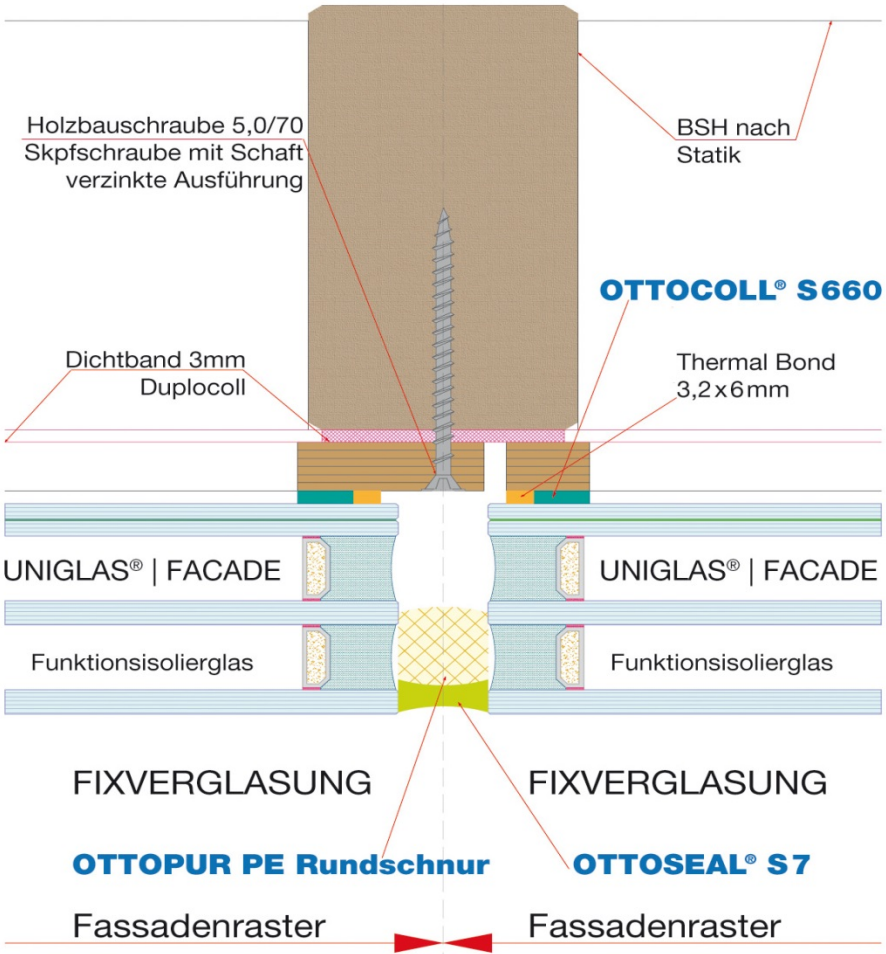

UNI GLAS® | **FACADE**
Holz-Glas-Verbundelement



Petschenig®
glasotec





Von der Forschung zur Realisierung F&E – UNIGLAS FACADE

SYSTEMSCHNITT PFOSTEN

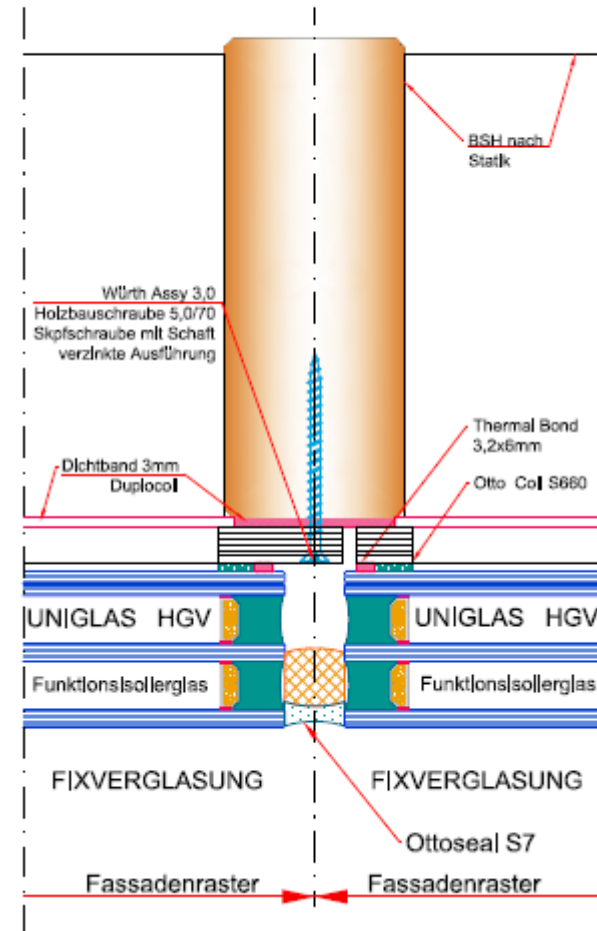
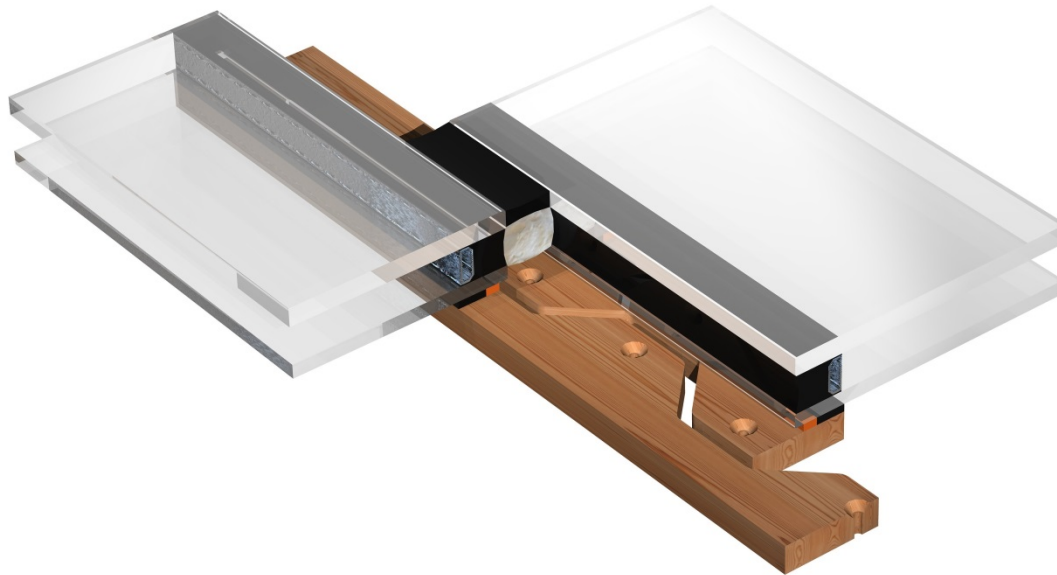



SYSTEMSCHNITT RIEGEL

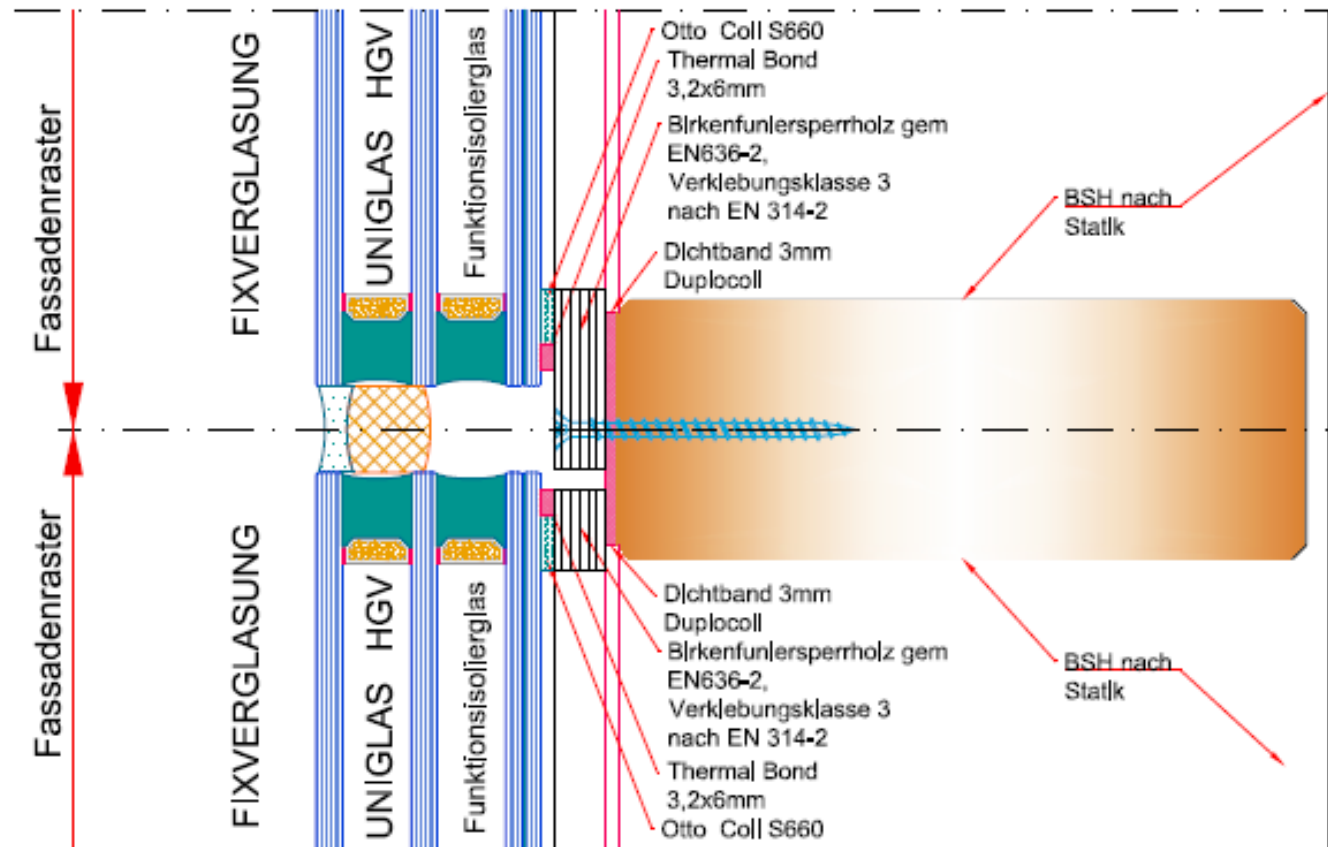



Isothermenberechnung

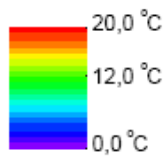
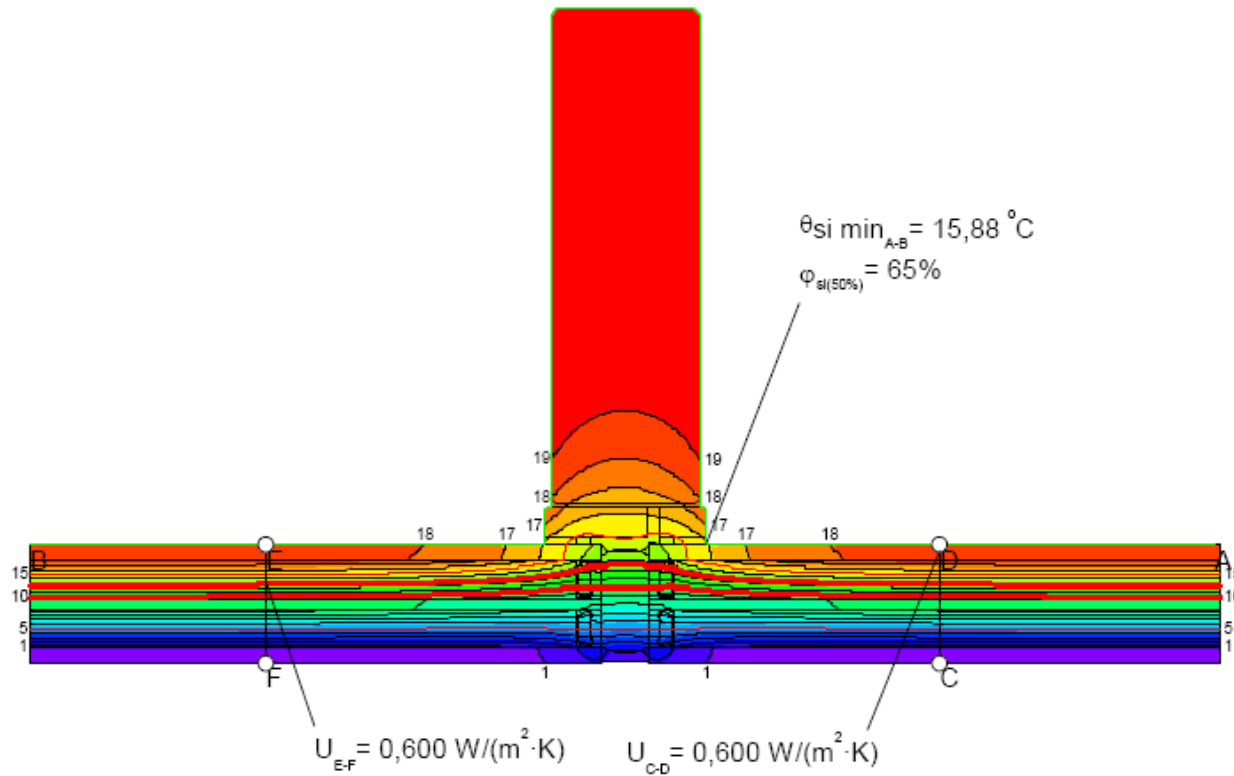



Bauphysik – $U_{cw} = 0,69 \text{ W/m}^2\text{K}$

Fassade / Wärmedurchgangsberechnung U_{cw}
20.03.2013 | Auftragsnr. 13/0155_01A | Kundennr. 1373 | Zeichen avH | Seite 1/5 gbu LAB



Prüfbericht

Wärmedurchgangskoeffizient nach EN ISO 12631 im akkreditierten Bereich

Auftraggeber	Uniglas GmbH + Co.KG	Adresse	Robert-Bosch-Straße 10 D - 56410 Montabaur
---------------------	----------------------	----------------	---

Bezeichnung	Uniglas Fassade	Identifikation	Regelement Fixbereich
Rahmenmaterial	Holz	Abmessungen	Breite 1400 mm Höhe 3000 mm

Produktnorm	Vorhangfassaden	EN 13830
--------------------	-----------------	----------

Füllung	Abstandhalter	flächenbezogener Wärmedurchgangskoeffizient	Vorhangfassade
U_g [W/(m ² ·K)]	Ψ [W/(m·K)]	$U_{T,2}$ [W/(m ² ·K)]	U_{cw} [W/(m ² ·K)]
6/16/4/16/6 0,6	Chromatech Ultra	2,00	0,69

gbu LAB

Akkr. Prüf- und Inspektionsstelle
gbd Lab GmbH | www.gbd.at
Steinbach 13a | 68850 Dornbirn

Dieses Deckblatt kann als Kurzfassung verwendet werden.
Wir behalten alle Rechte in diesem Dokument und in den Informationen vor, die darin enthalten sind. Missbrauch oder Weitergabe an dritte
Personen ist ohne ausdrückliche Berechtigung verboten. Prüfbericht Version: 2.08*

Akreditierte Prüf- und Inspektionsstelle - gbd Lab GmbH FN23953101
Steinbach 13a A-6850 Dornbirn T +43 5572 394830-0 F +43 5572 394830-38 office.lab@gbd.at www.gbd.at



ERGEBNISSE Bauphysik 01.2015





ERGEBNISSE Bauphysik 01.2015

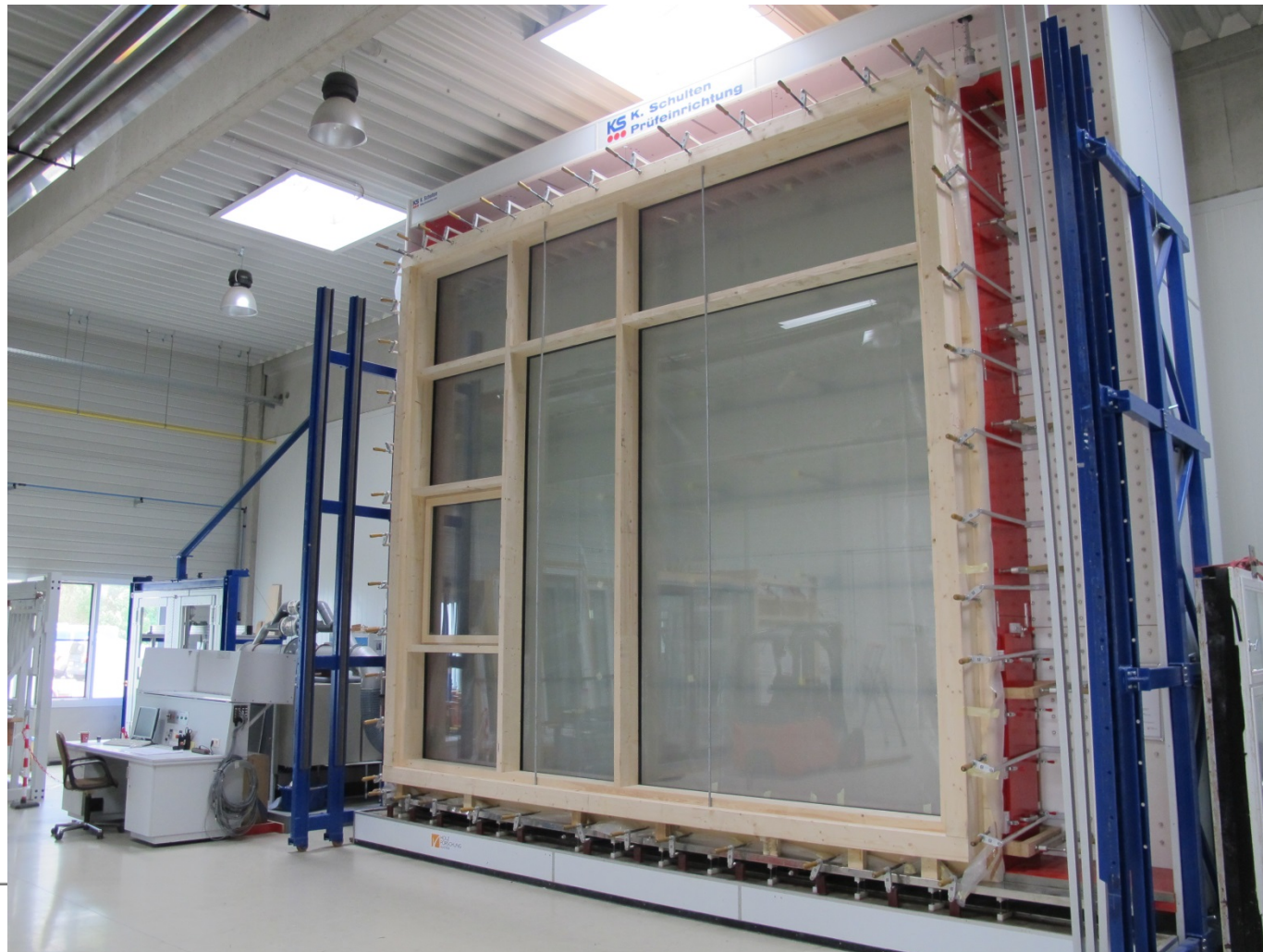



ERGEBNISSE Bauphysik 01.2015

- Hervorragende Wärmedämmung – U_{cw} 0,69 W/m²K mit U_g 0,6 W/m²K
- Luftdurchlässigkeit ÖNORM EN 12153 Klass. ÖNORM EN 12152 = AE1050
- Schlagregendichtheit ÖNORM EN 12155 Klass. ÖNORM EN 12154 = RE 1050
- Schlagregendichtheit offenbare Elemente ÖNORM EN 12155 Klass.
ÖNORM EN 12154 = RE 750 R6
- Widerstand gegen Windwiderstand ÖNORM EN 12179 Klass. ÖNORM EN 13116 =
+ 3,0 kN/m² Druck - 3,0 kN/m² Sog
- Stoßfestigkeit ÖNORM EN 13049 Klass. ÖNORM EN 14019 = außen E5 innen I4
- Bedienkräfte ÖNORM EN 12046-1 Klass. ÖNORM EN 13115 = 2
- Pendelschlag nach EN 12600 Kat. A DIN 18008 - 900mm Pendelfallhöhe
min. Format 540 x 800 mm, max. Format 2480 x 3540 mm



- Pet
- der
- WO
- Deu
- sich
- iniz
- In u
- Kle
- und



g
ung
hile
a
ern



Herzlic



rksamkeit

