

Ingenieurbüro **INGergy**

Gebäude und Energietechnik

Paul G. Graf von Westphalen
Dipl. -Ing. (FH)

zertifizierte Gutachter und Sachverständiger für

- Schäden an Gebäuden
- Schimmel und Feuchte
- Energetische Maßnahmen

Ingenieurbüro für Energie und Bauphysik
Griegweg 80
82538 Geretsried



Sanierungsberichte aus der Praxis

Gebäudehülle



Haustechnik

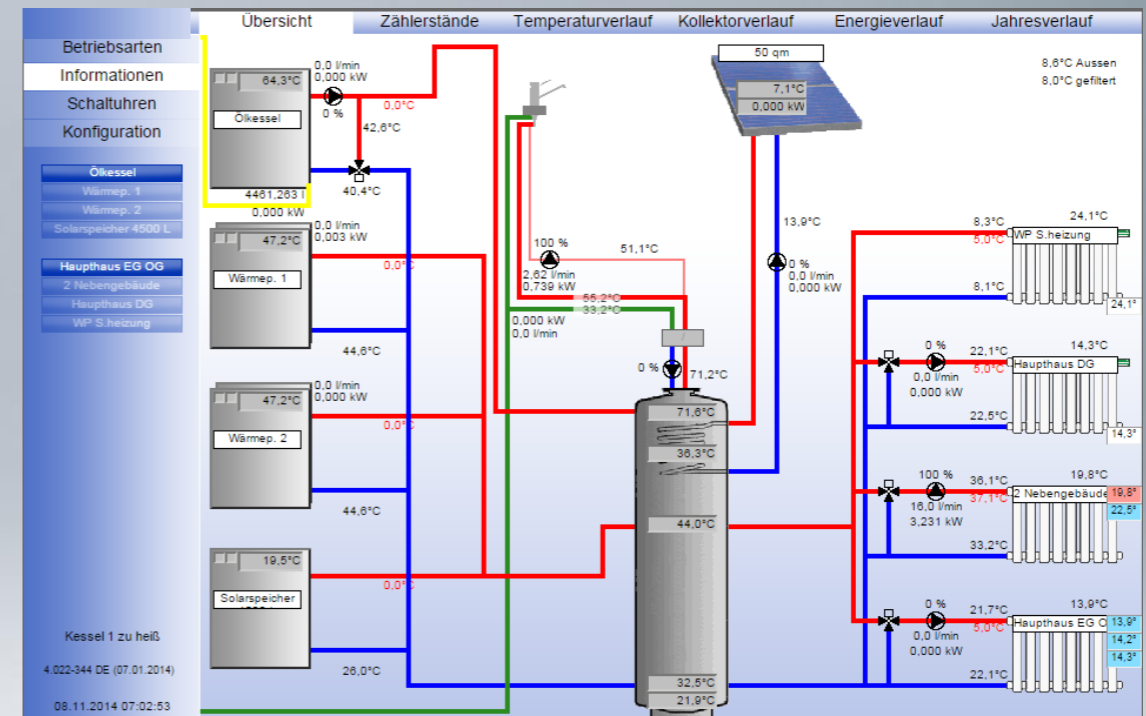

Sanierungsberichte aus der Praxis

Dämmung ohne Schimmel und Algen

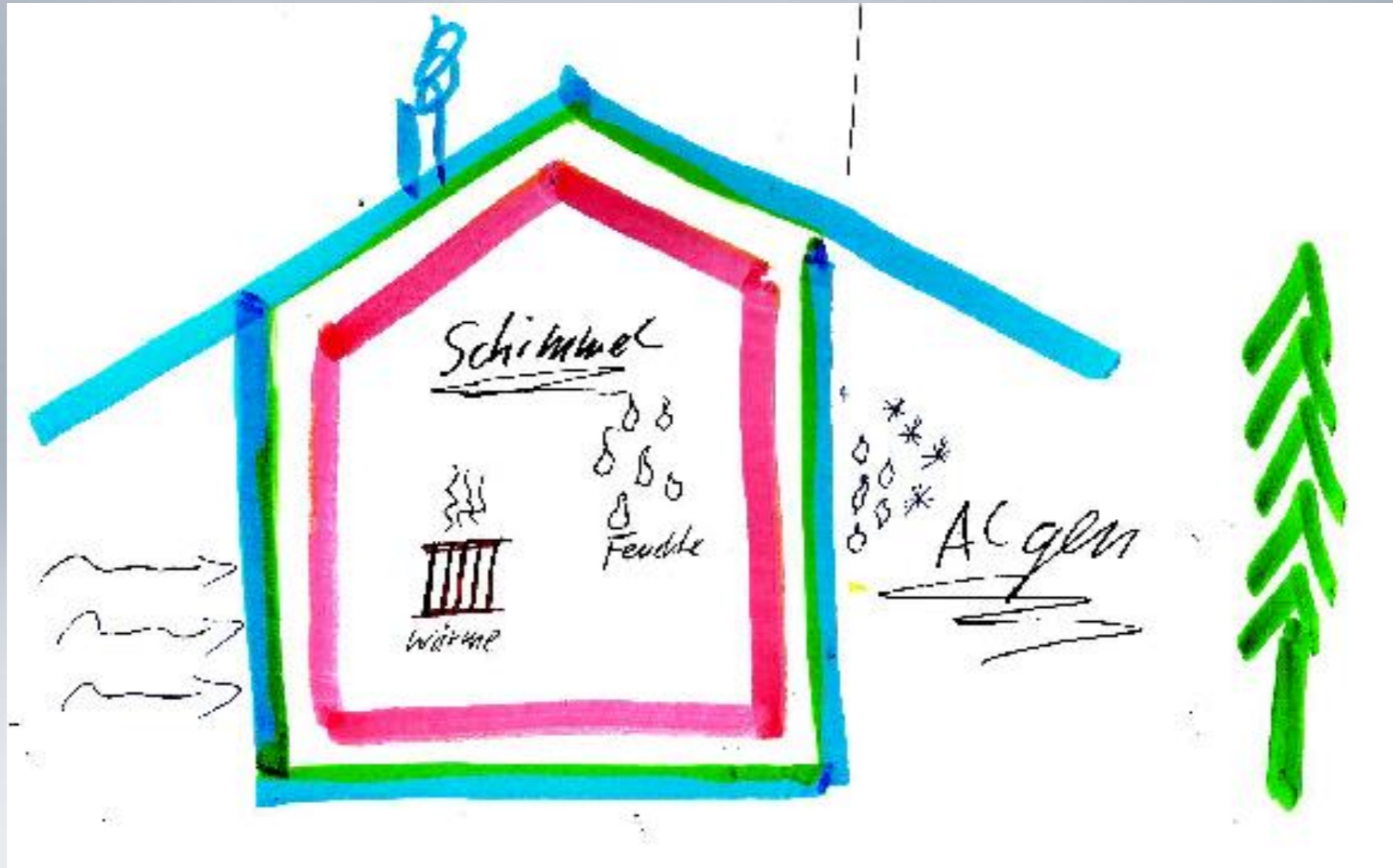

Sanierungsberichte aus der Praxis

Temperatur und
Taupunkt-
verschiebung

Gebäudehülle

Mit der Sanierung
kommt der
Schimmel

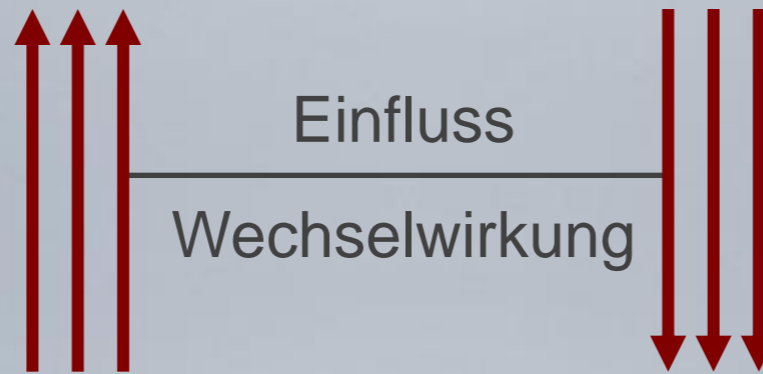

Der Schimmel
wurde
„plattgeheizt“

Gebäudetechnik

Beheizbarkeit

Sanierungsberichte aus der Praxis

Darum ist Wärmebrückenfreiheit so wesentlich

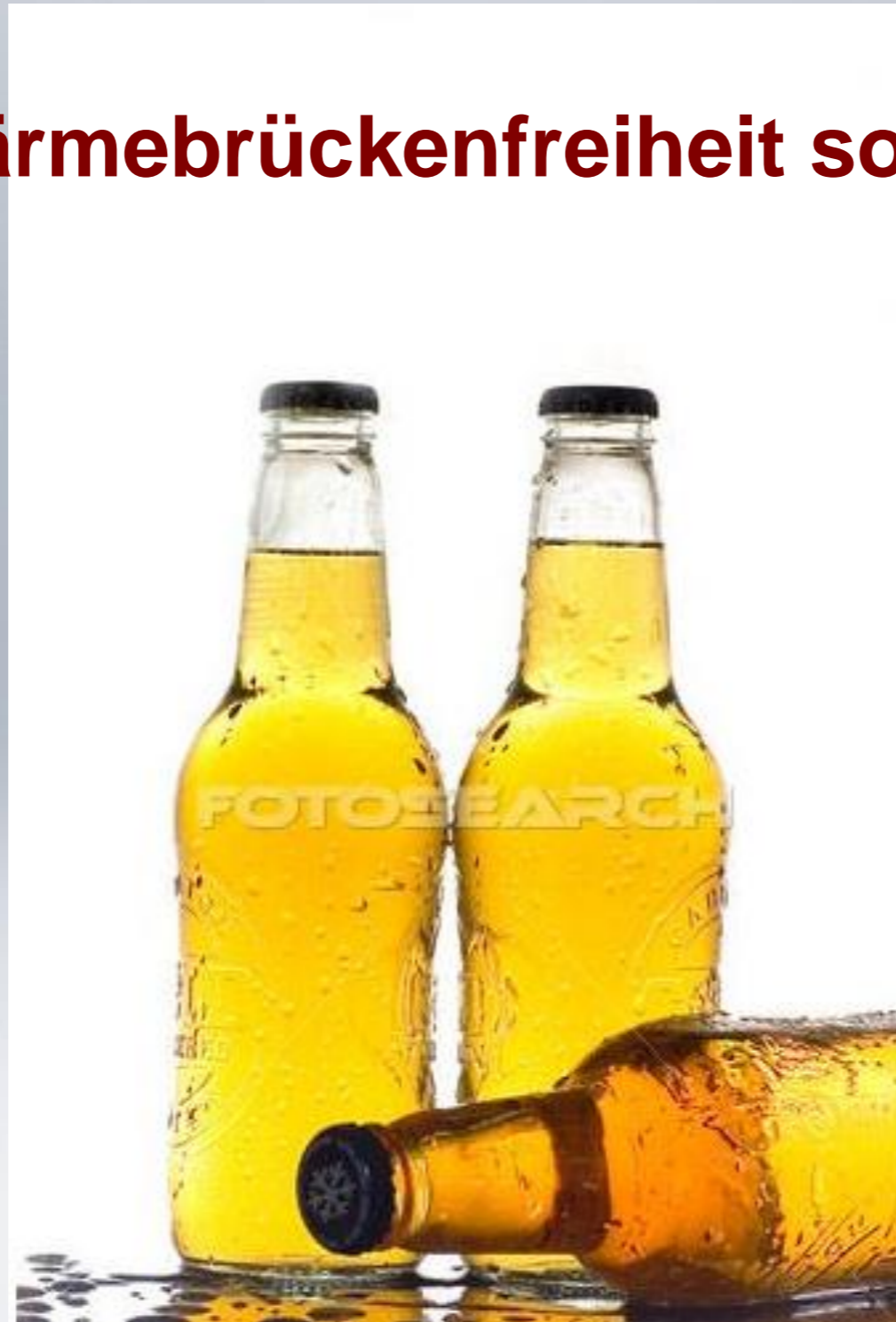

Sanierungsberichte aus der Praxis

Wärmebrücke und Schimmel

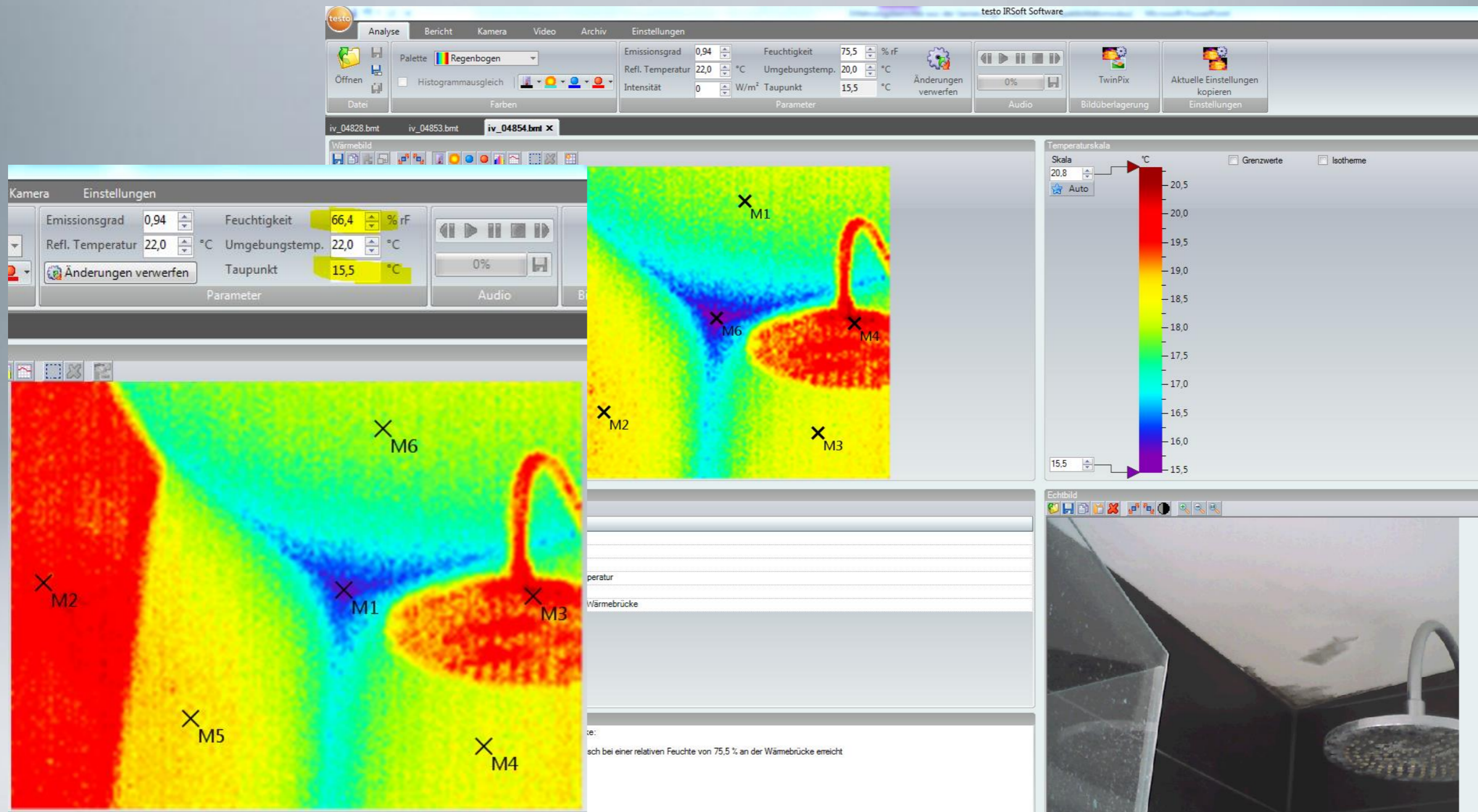

Sanierungsberichte aus der Praxis



Sanierungsberichte aus der Praxis

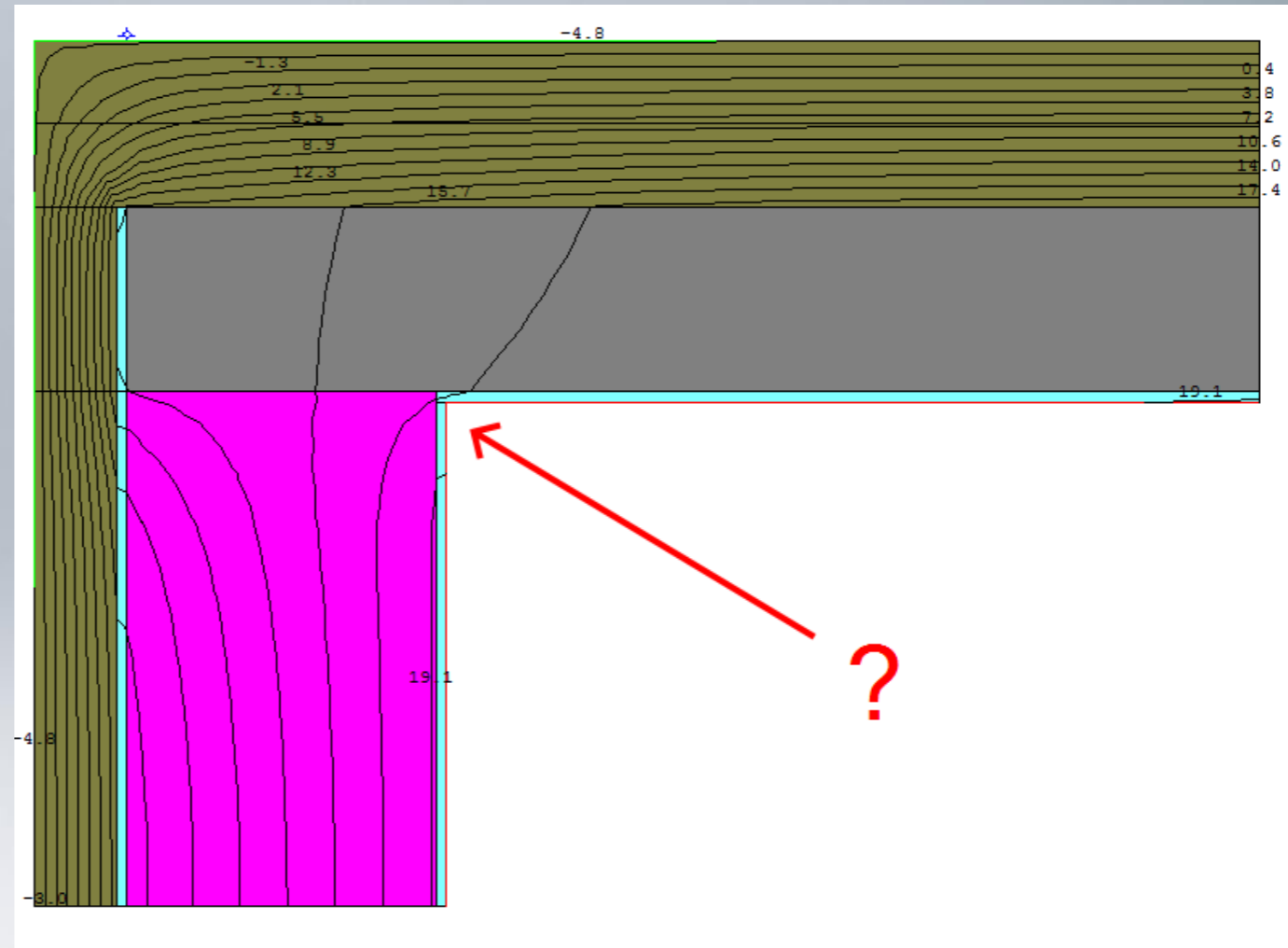
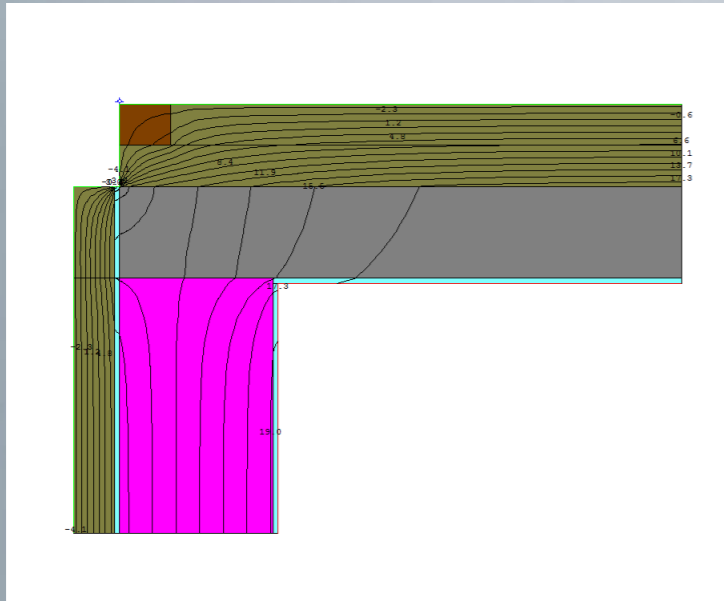

Sanierungsberichte aus der Praxis

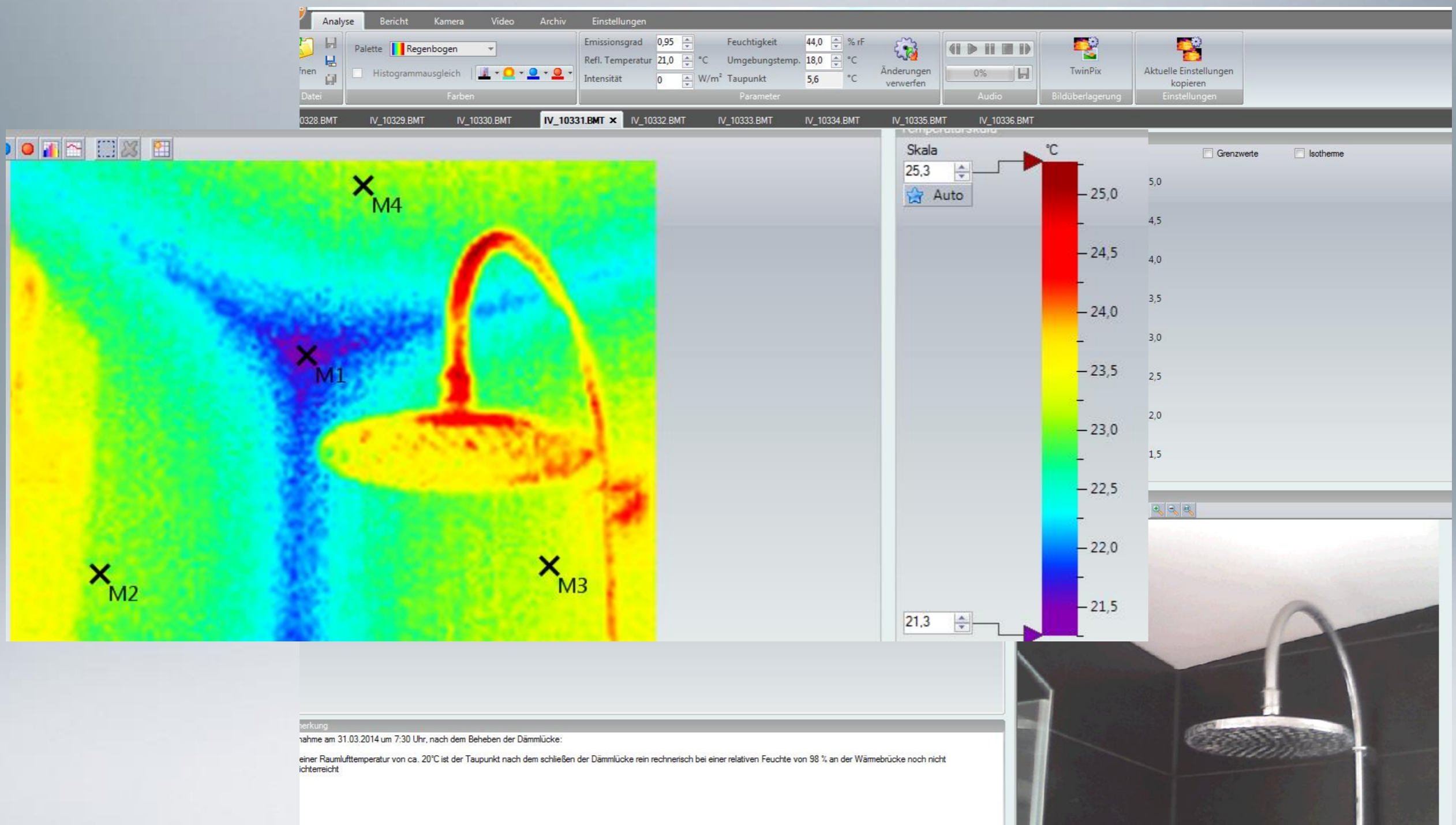

Sanierungsberichte aus der Praxis

Flachdach, immer eine Herausforderung



Sanierungsberichte aus der Praxis

Flachdach, immer eine Herausforderung

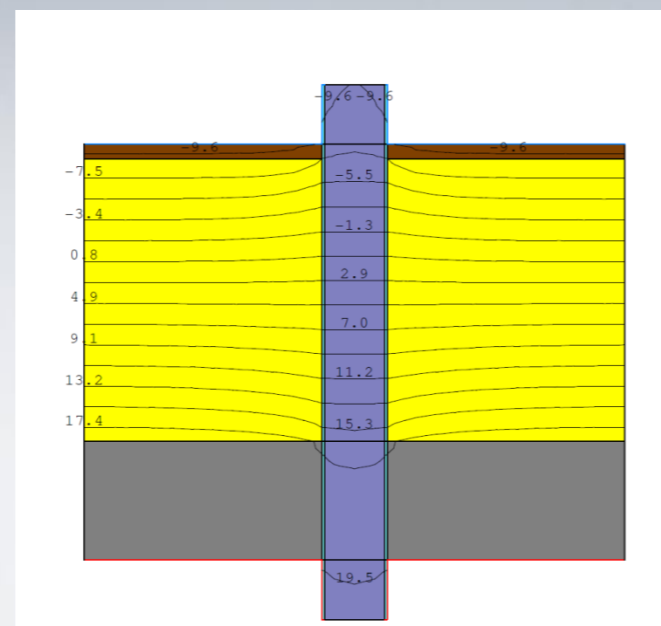
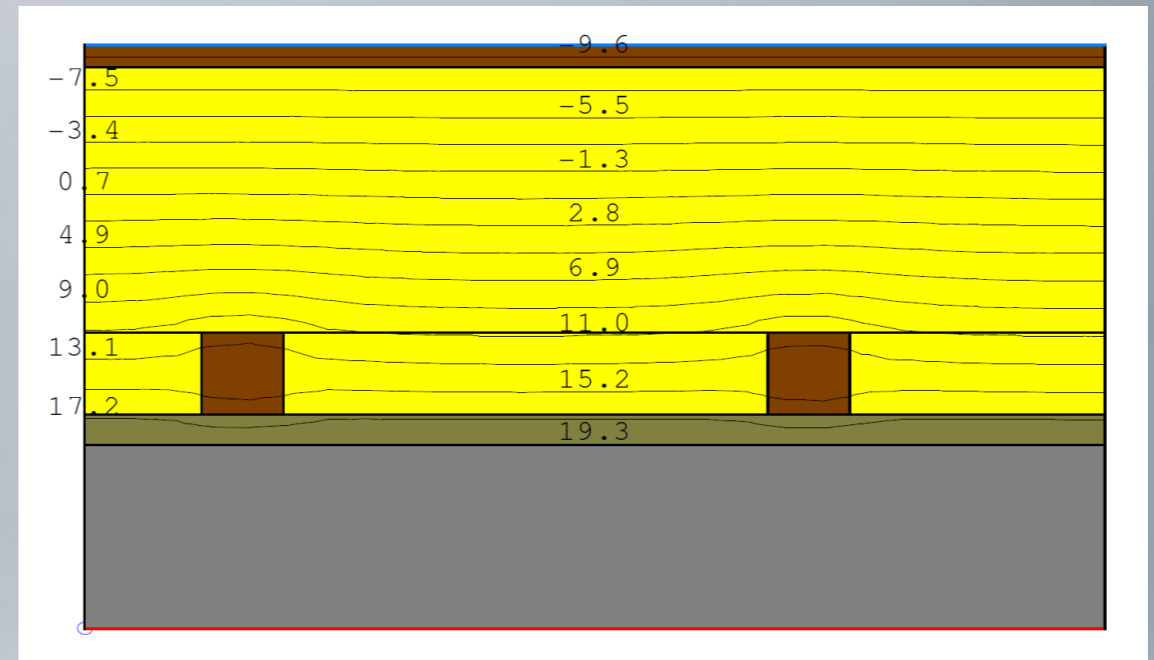
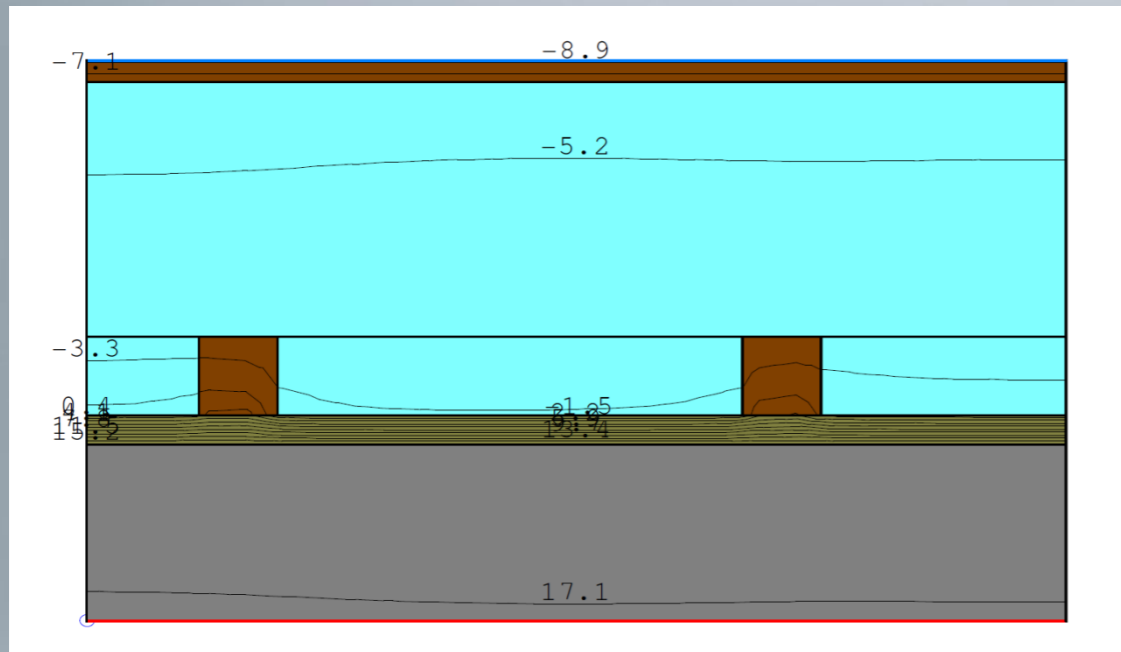

Regeln statt schalten

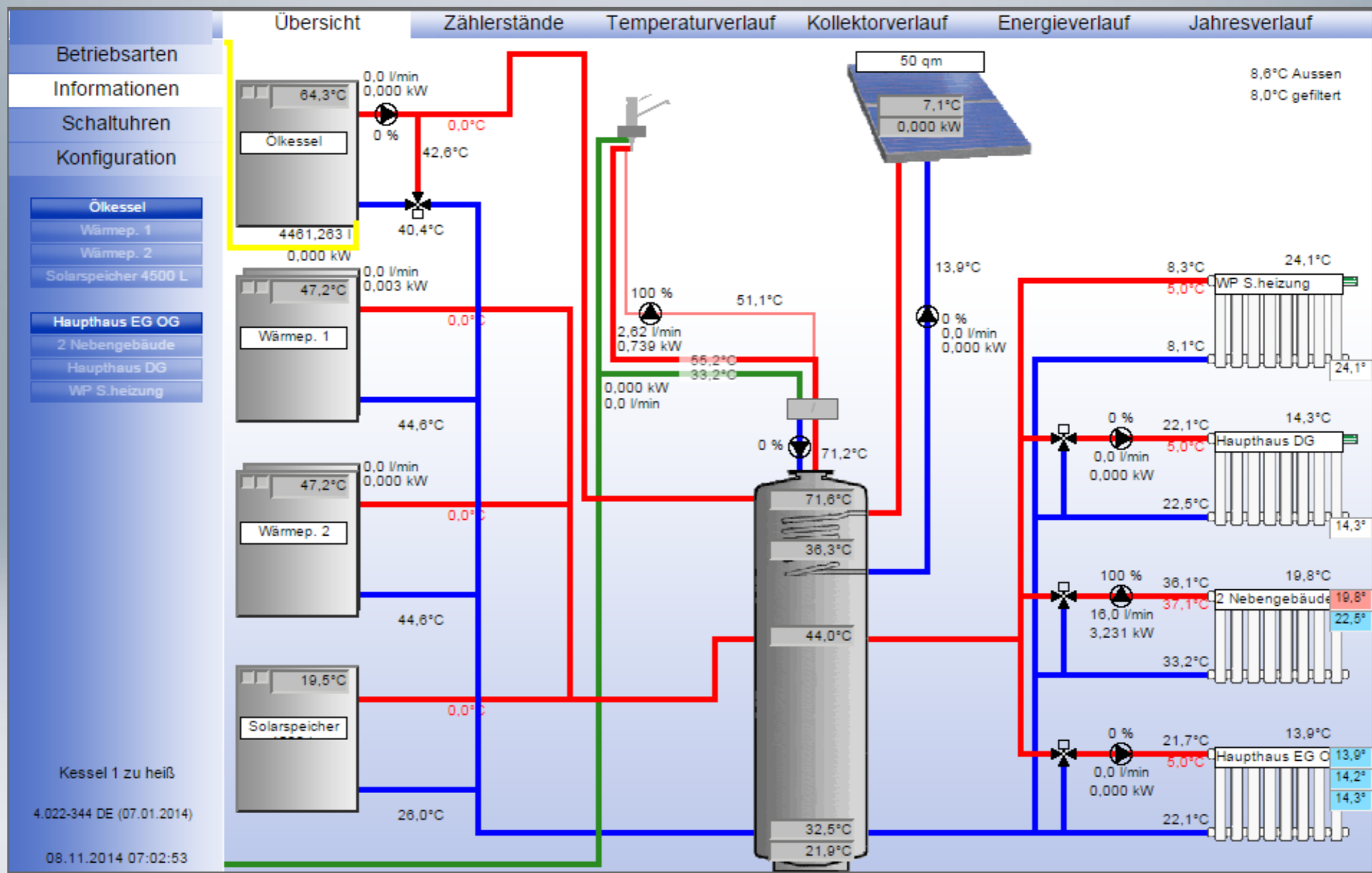

Sanierungsberichte aus der Praxis

Luftdichtheit wird immer wichtiger



Sanierungsberichte aus der Praxis

Luftdichtheit wird immer wichtiger

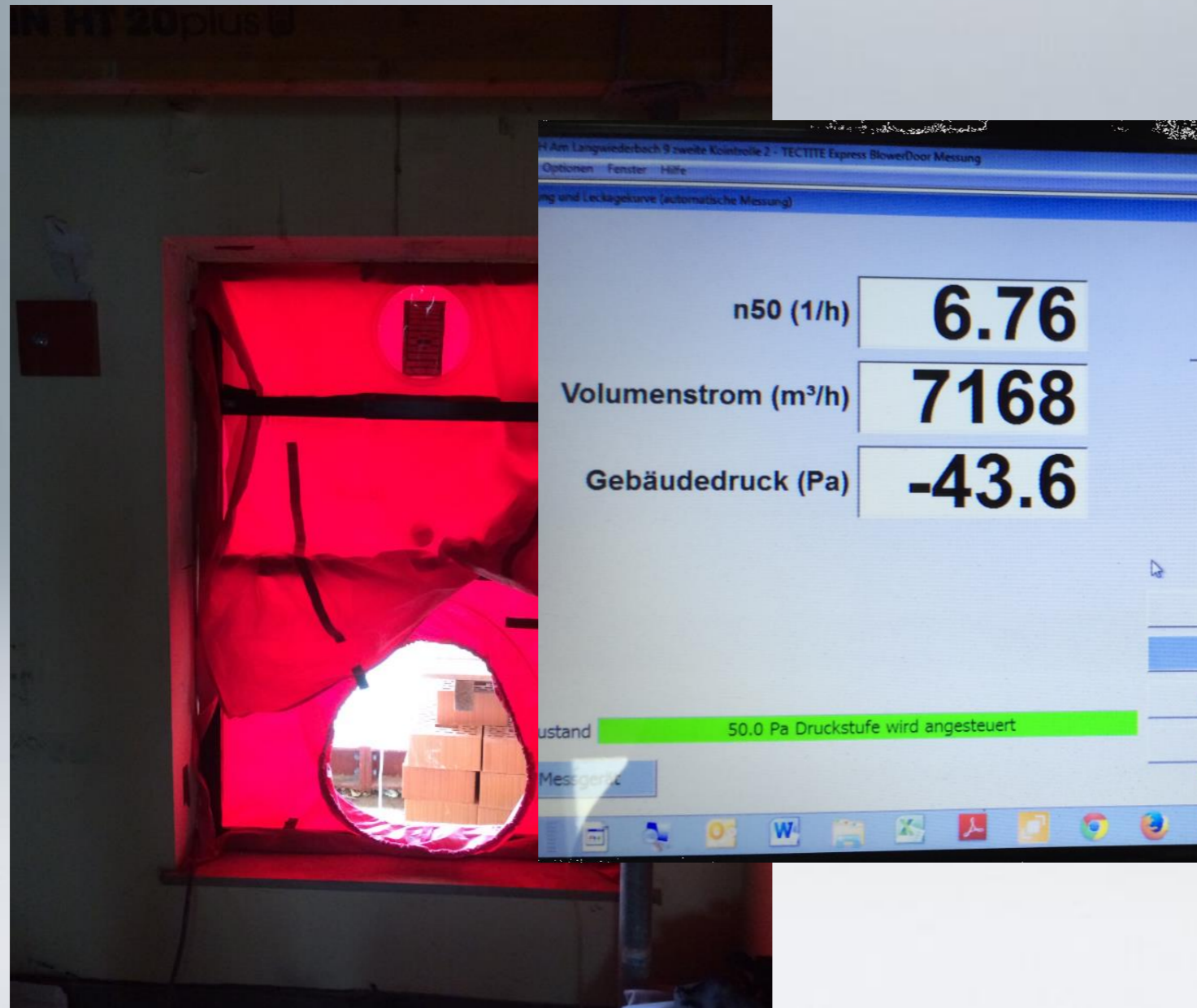

Sanierungsberichte aus der Praxis

Luftdichtheit wird immer wichtiger

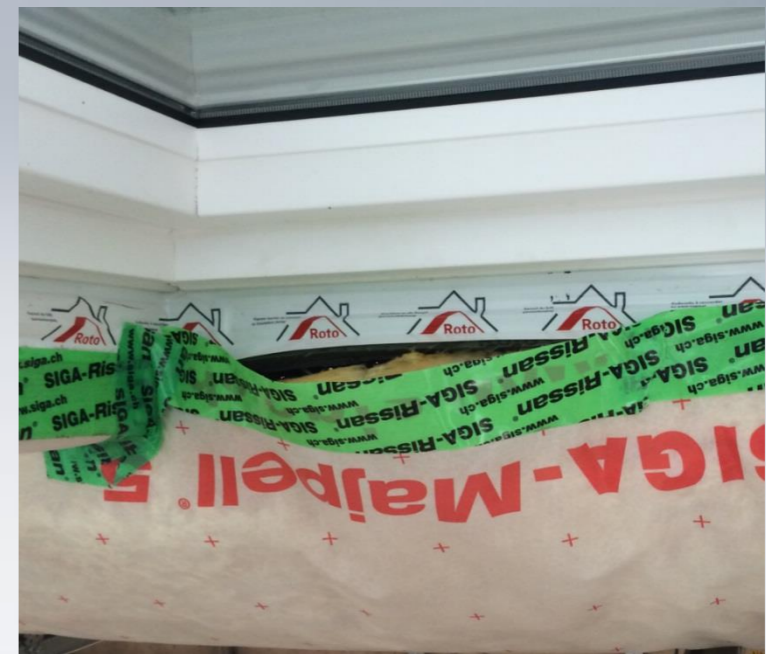

Sanierungsberichte aus der Praxis

Luftdichtheit wird immer wichtiger

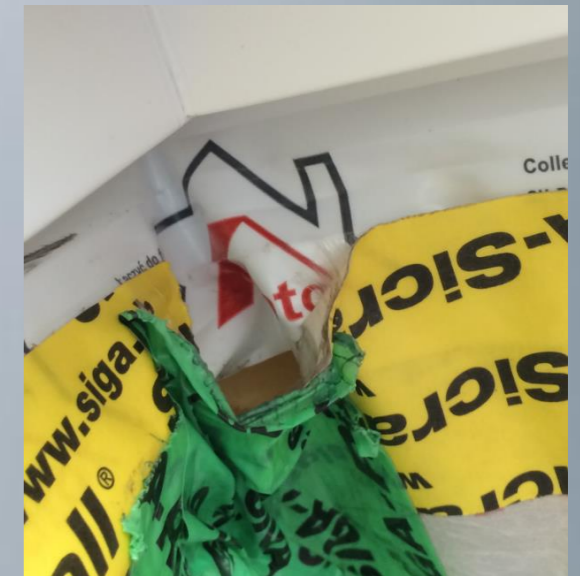
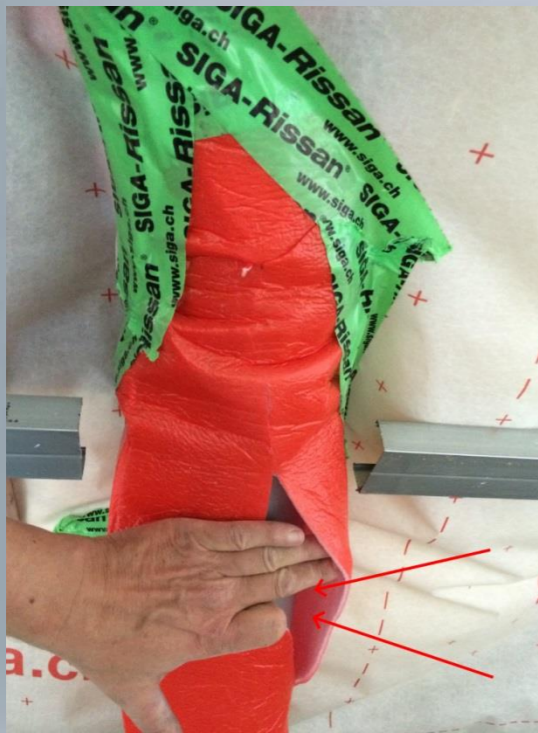

Sanierungsberichte aus der Praxis

Luftdichtheit wird immer wichtiger



Sanierungsberichte aus der Praxis

Luftdichtheit wird immer wichtiger



Regeln statt schalten

geplante Haustechnik

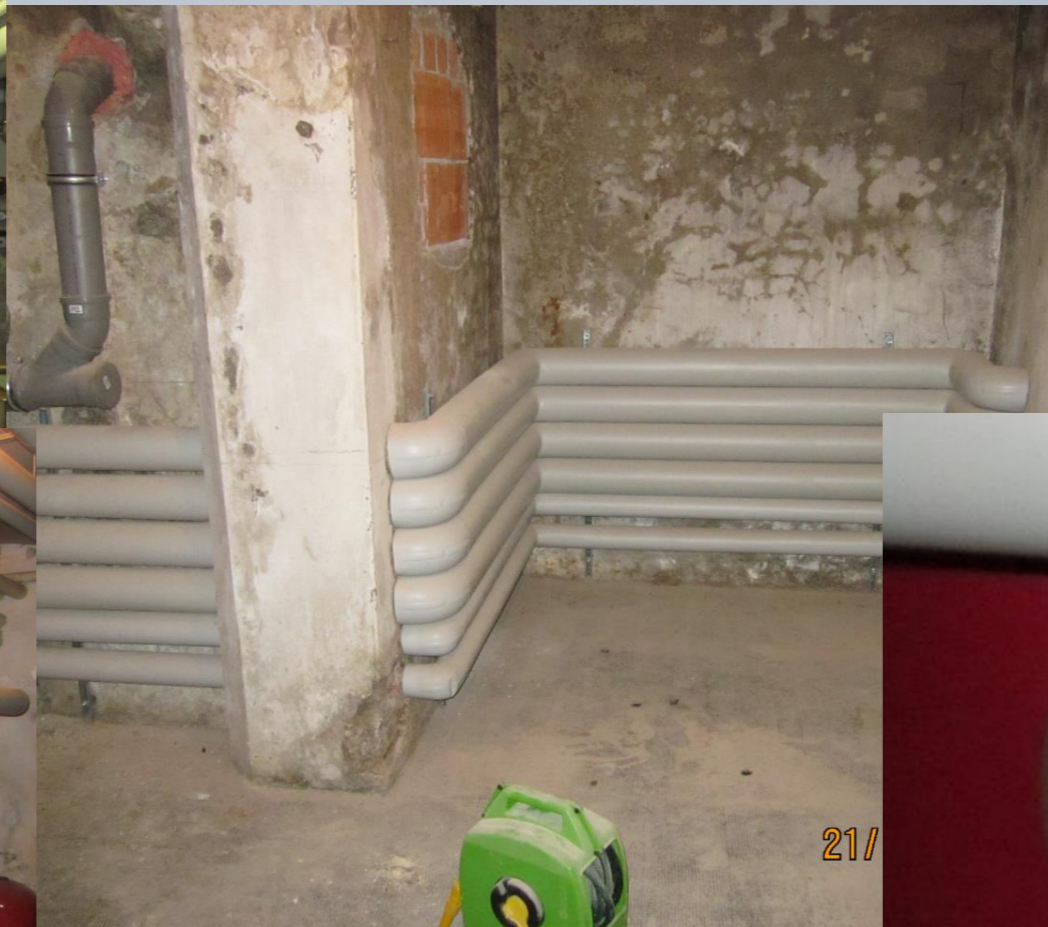

Regeln statt schalten

alte Haustechnik, zum Teil unverändert

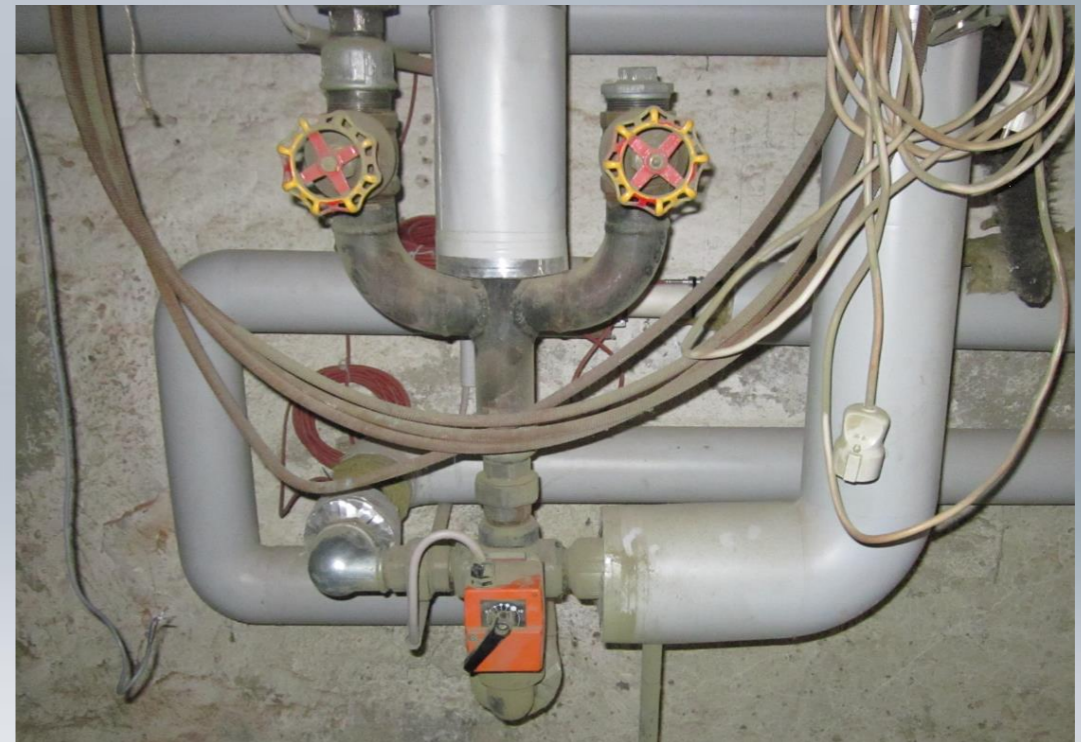

Sanierungsberichte aus der Praxis

geplante Haustechnik

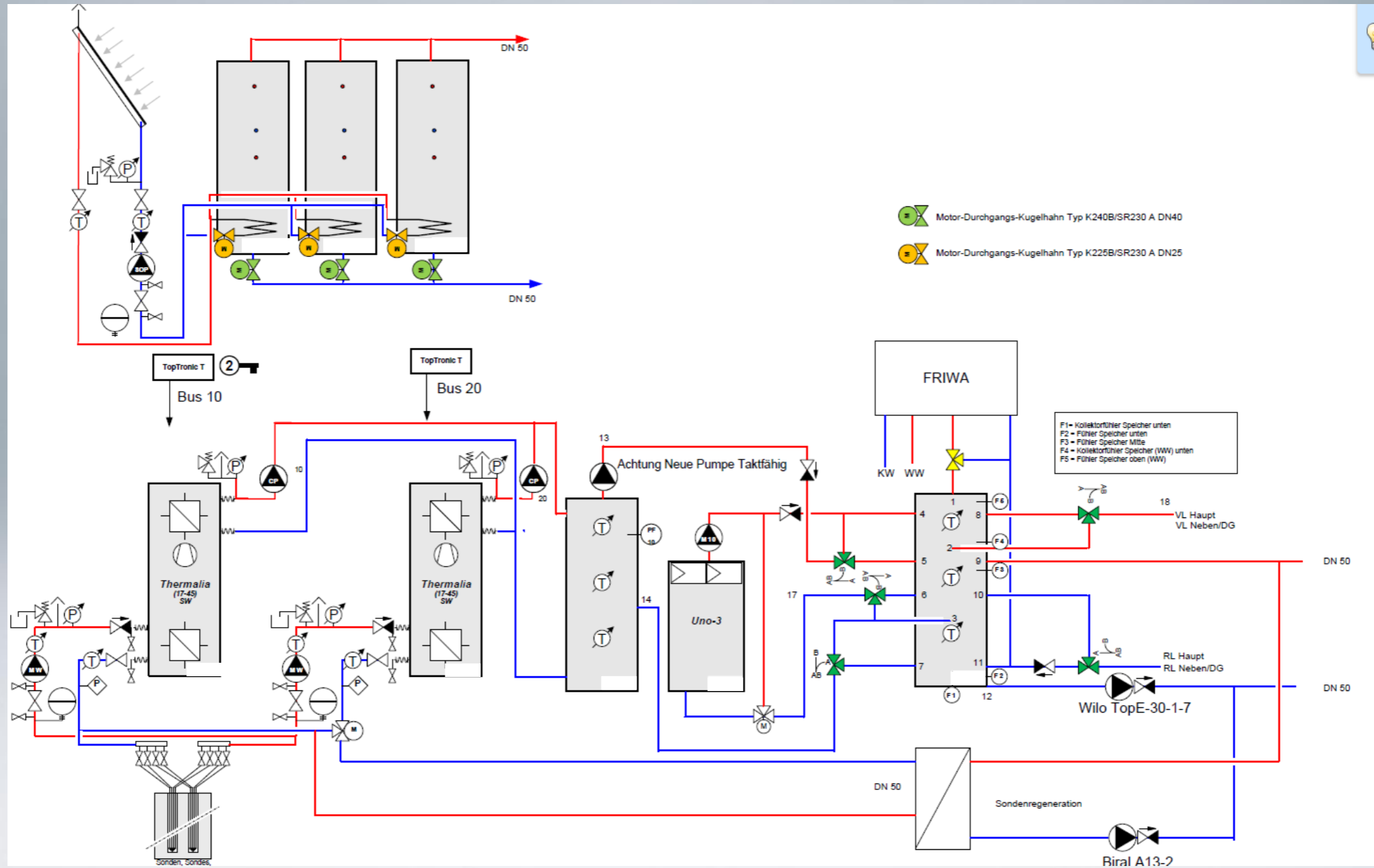

Regeln statt schalten

geplante Haustechnik

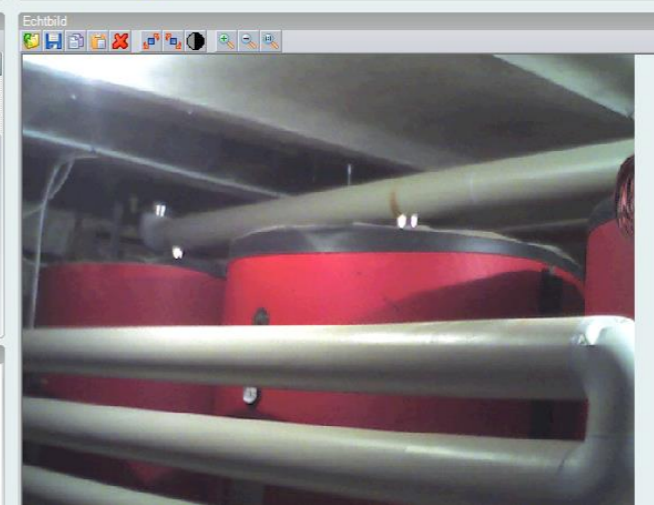
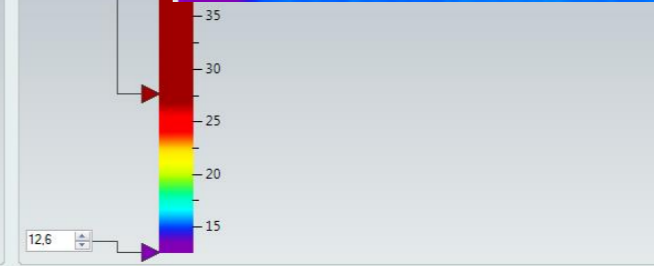
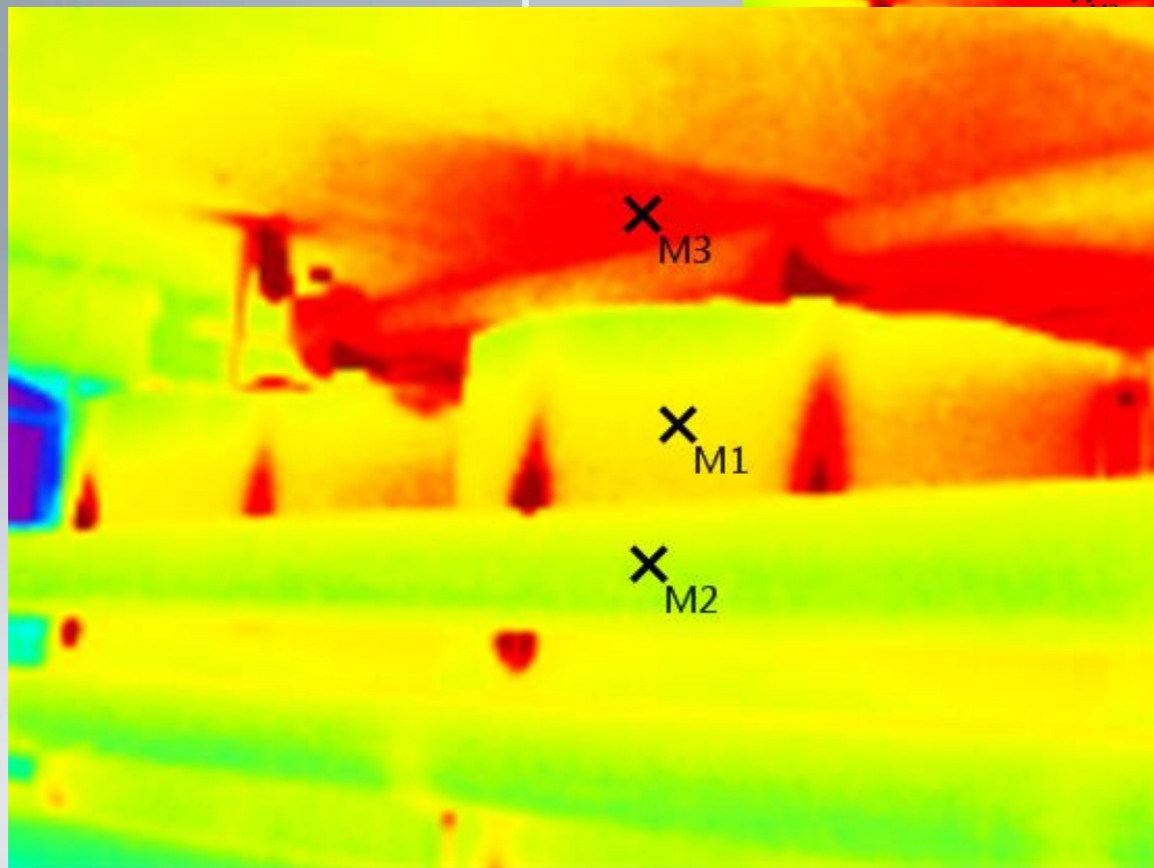
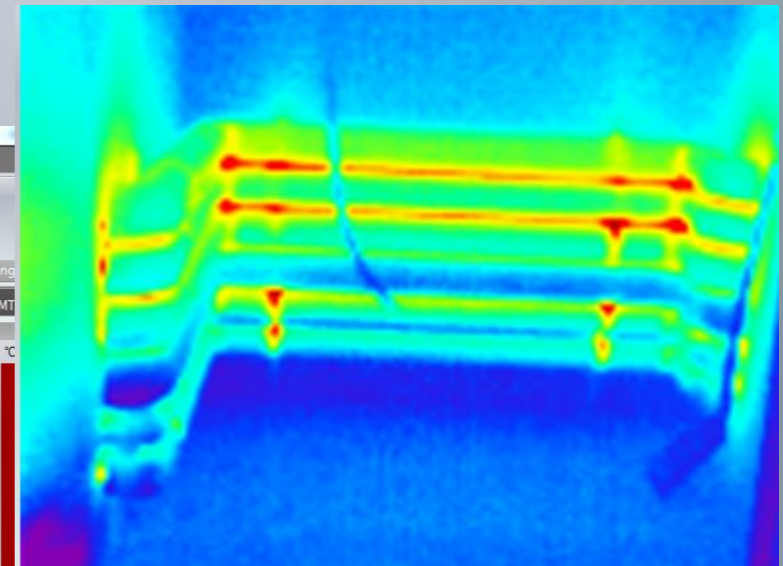
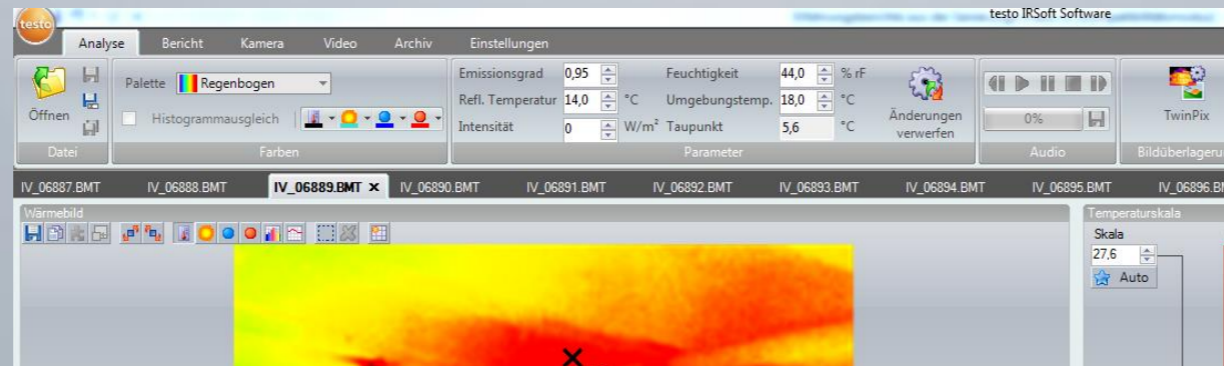

Sanierungsberichte aus der Praxis

Danke für Ihre Aufmerksamkeit

