

# Tageslicht gewinnen und kontrolliert in die Tiefe des Raumes einlenken

Fachforum  
“Glas und Fenster”

München 15.03.2012

Dr.-Ing. Helmut Köster  
Köster Lichtplanung – Frankfurt/M  
[www.koester-lichtplanung.de](http://www.koester-lichtplanung.de)

# Ziel der Tageslichttechnik:

- Verminderung der Kühllast durch Retro-Reflexion
- Verminderung des Stromverbrauchs durch verbesserte Tageslichtautonomie



Energie AG, Linz

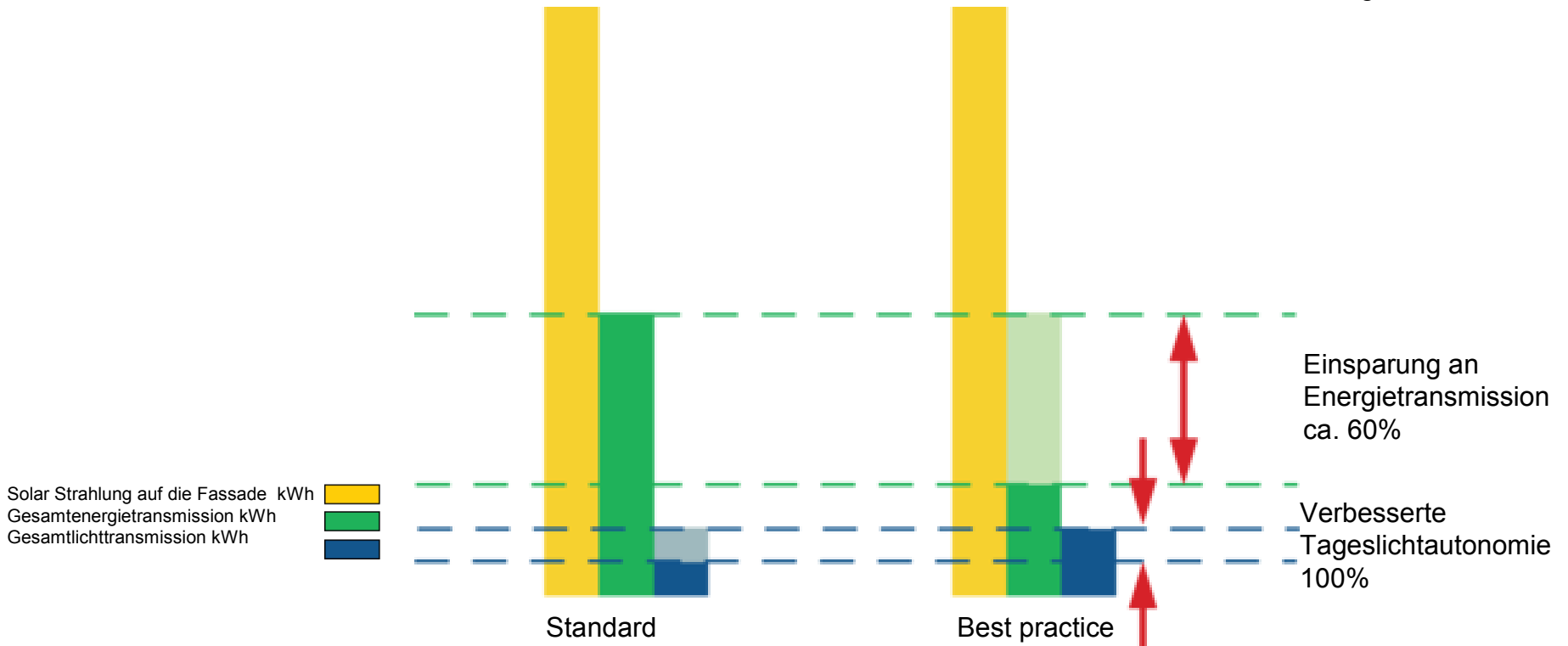



# Wärme oder Licht - ein Gegensatz?

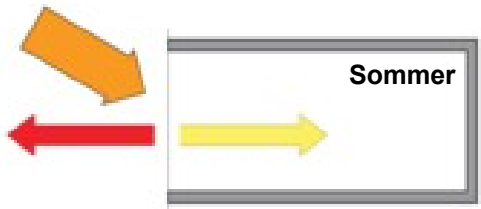
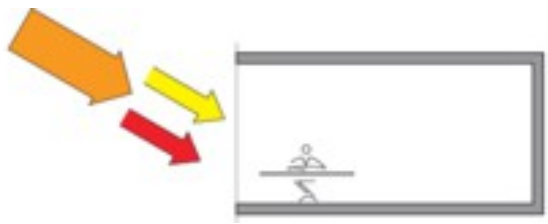

verbessertes Tageslicht,  
Überhitzung vermieden

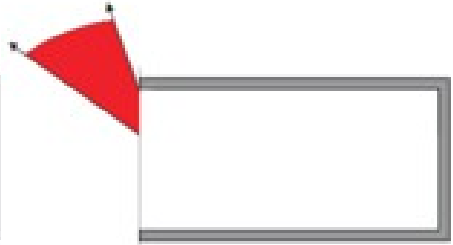

Retro-Reflexion  
Zurück in den Himmel

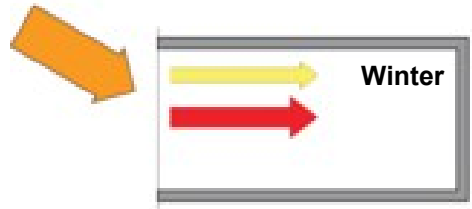

Licht- und solarer  
Energiezugewinn



Lichtumlenkung  
an die Decke



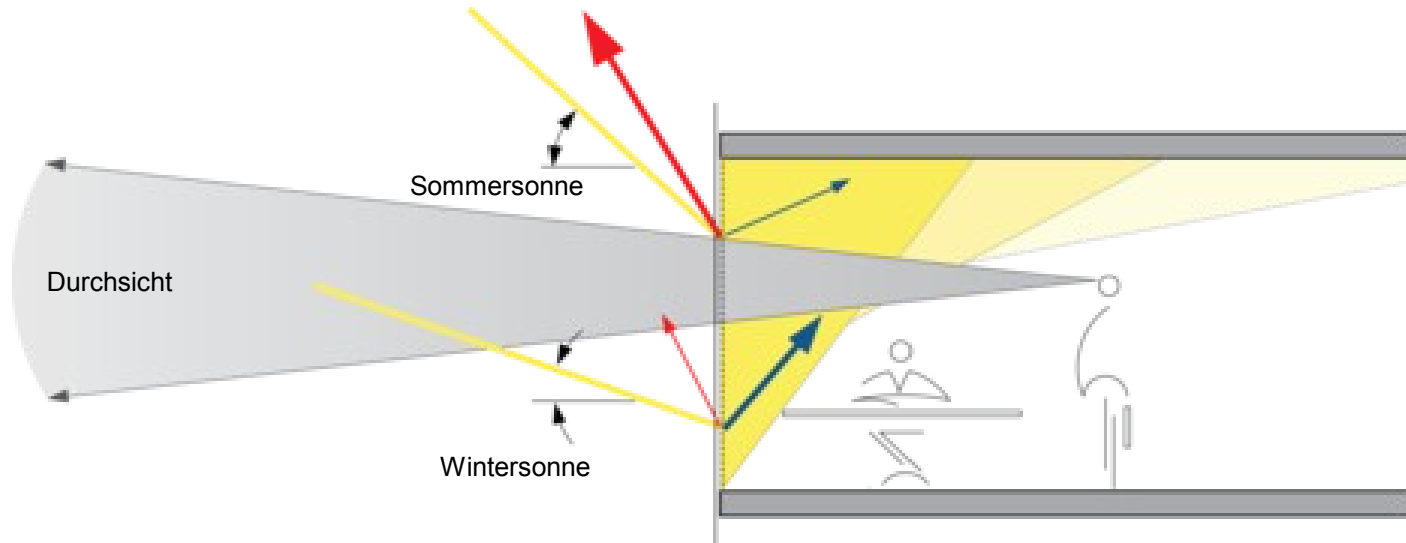

## Tageslichtkonzept

**Schutzfunktion**  
- vor Überhitzung  
- vor Blendung

**Passive Kühlung**  
durch Energieauslenkung

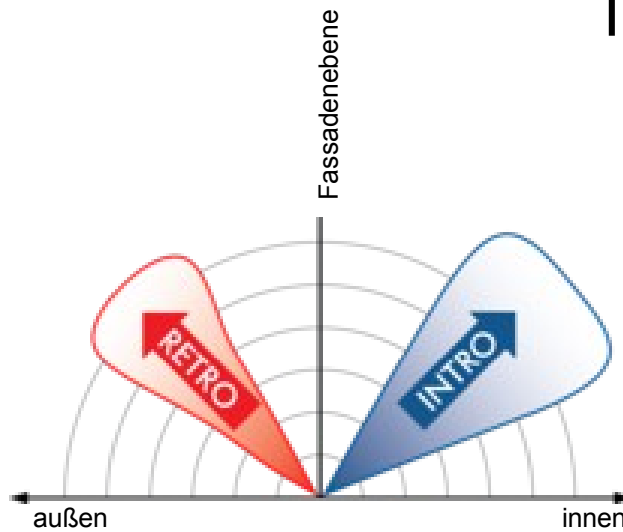

**Versorgungsfunktion**  
- für Tageslicht  
- im Winter mit Sonnenenergie

**Tageslichteinlenkung**  
In die Raumtiefe  
zur Verbesserung des  
Tageslichtquotienten

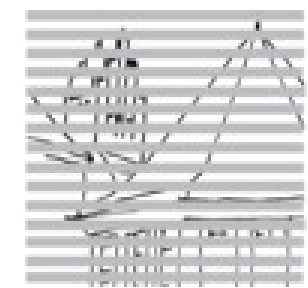
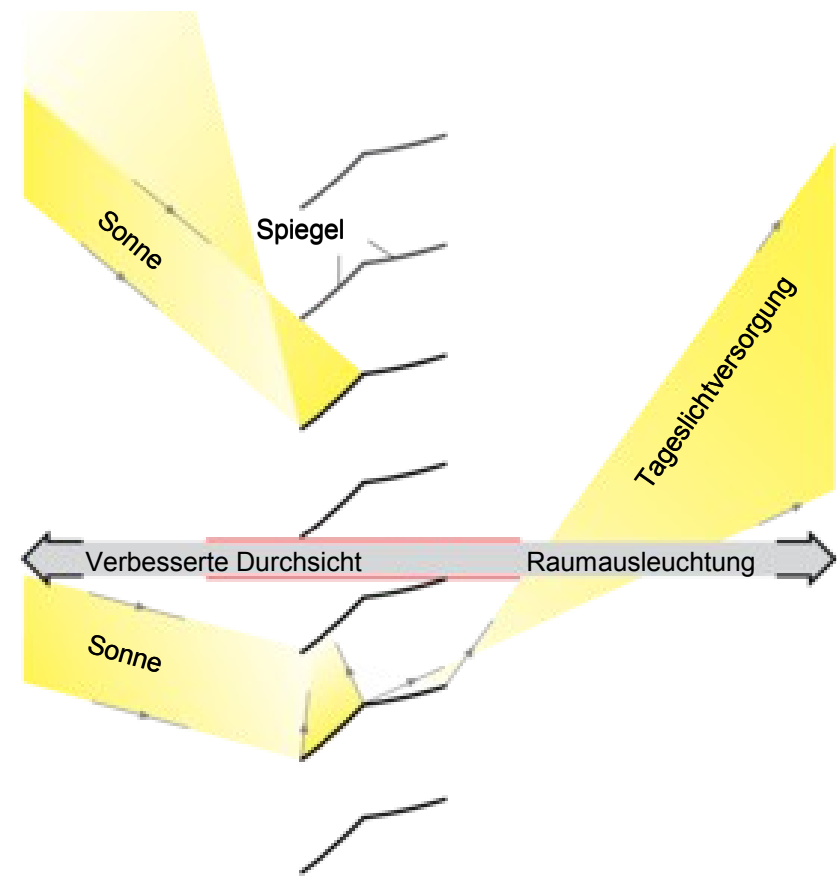
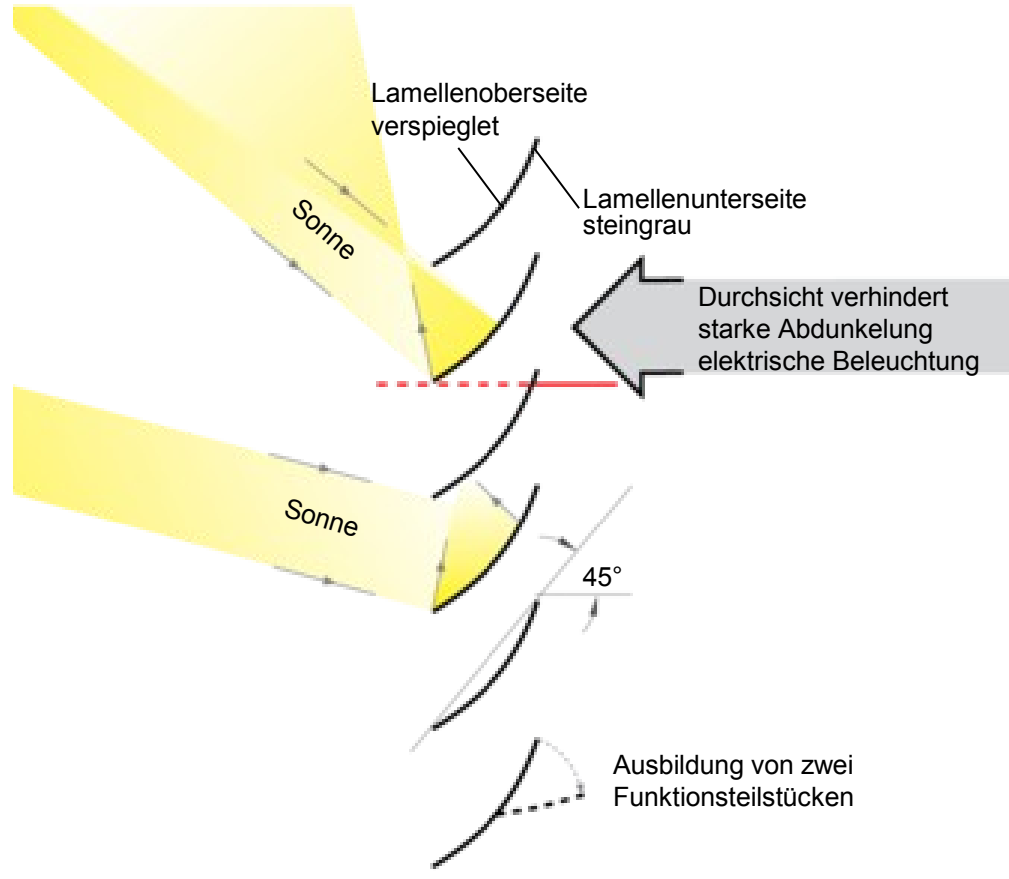

# RETROLux A

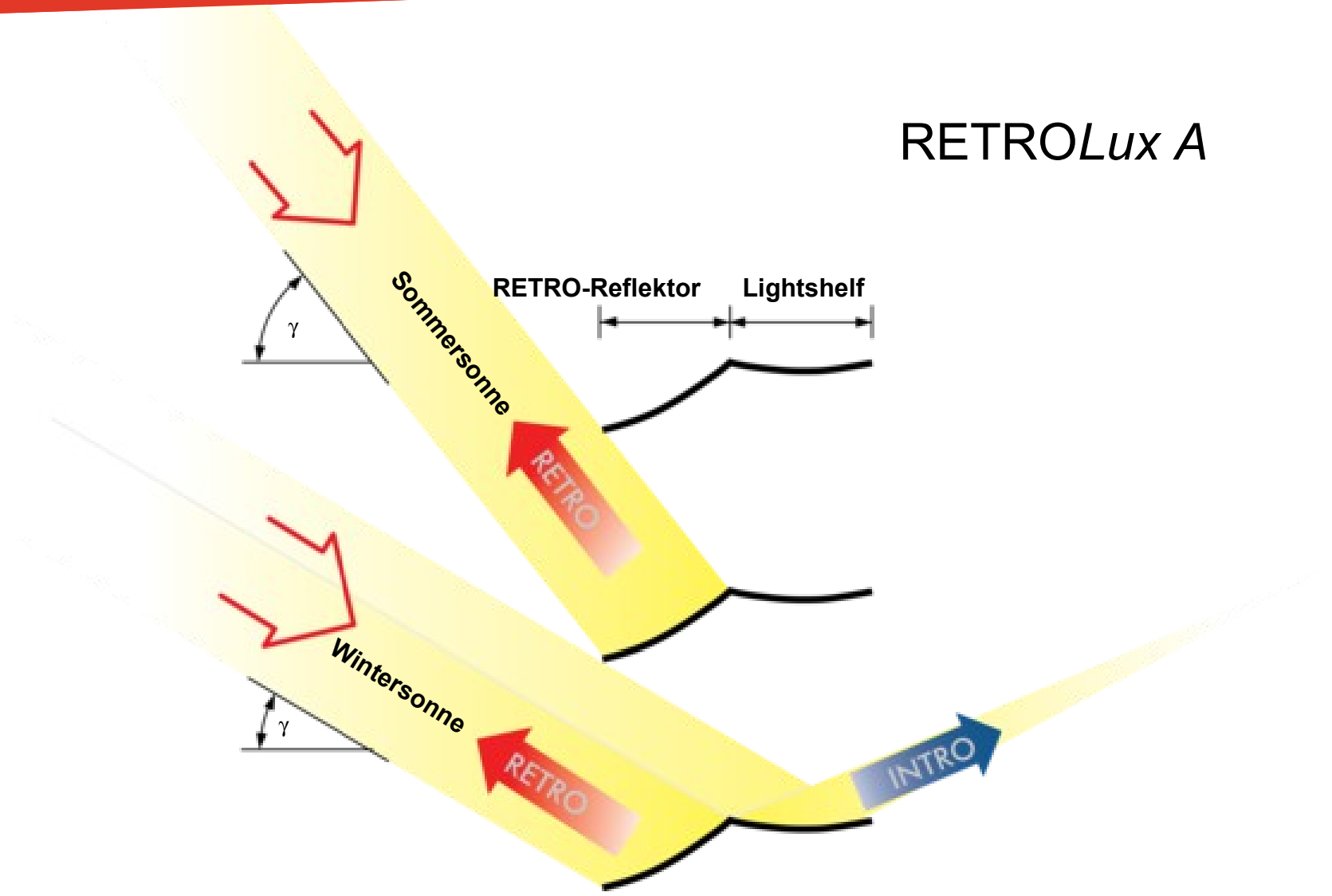

# Lichtlenkung

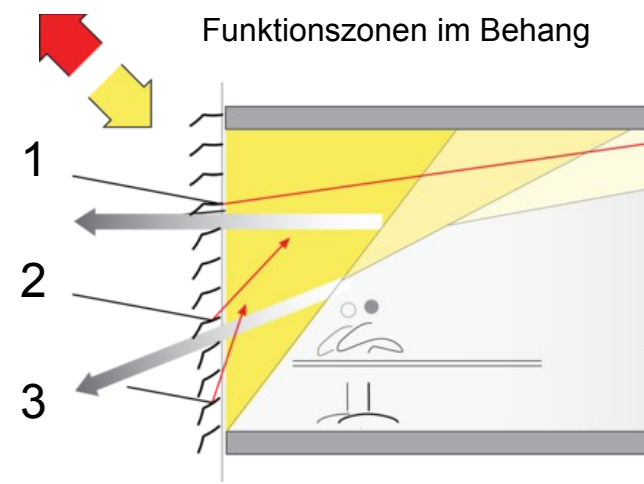
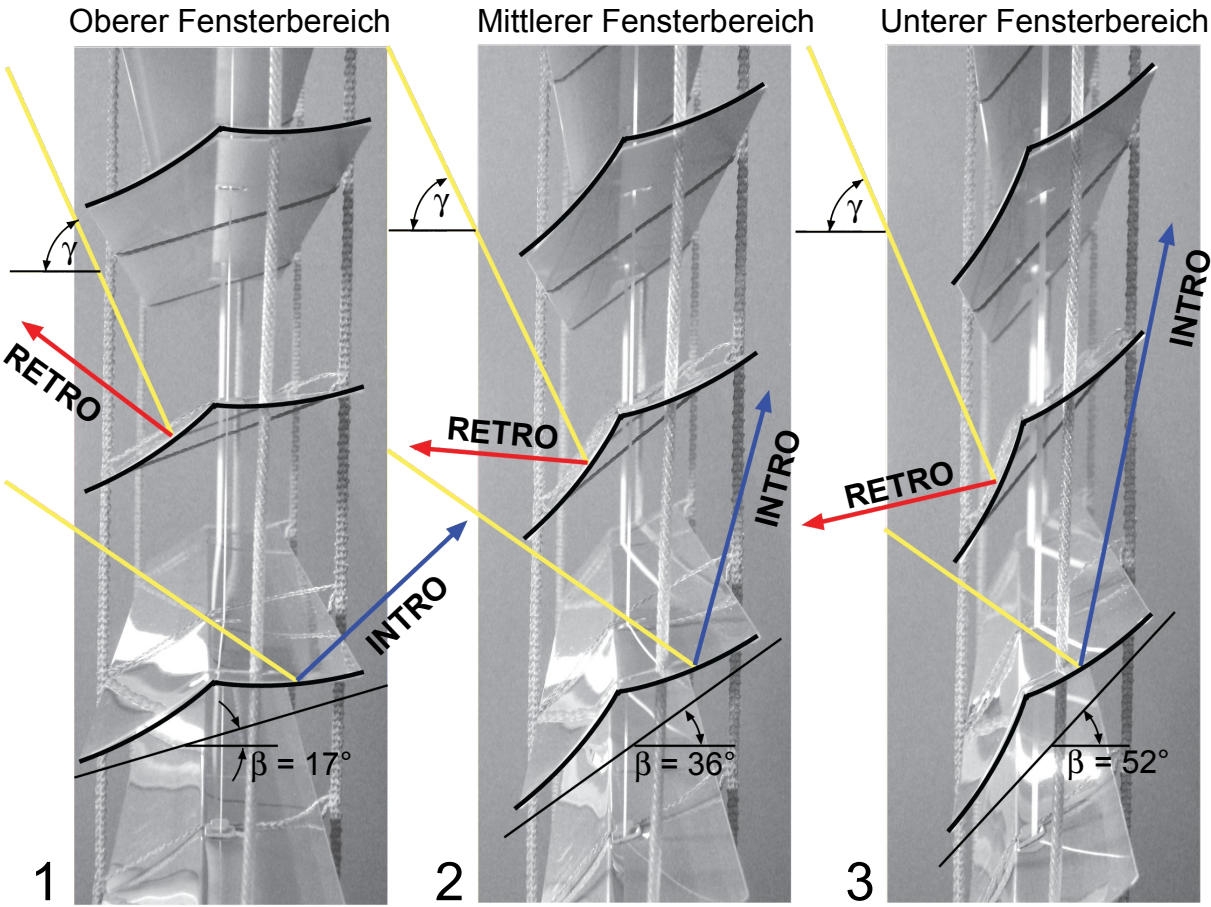



# Energiemanagement durch Lichtlenkung

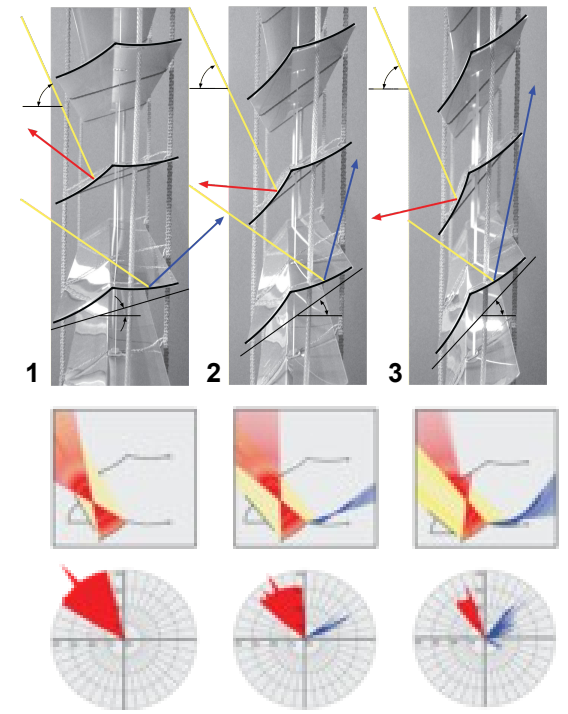
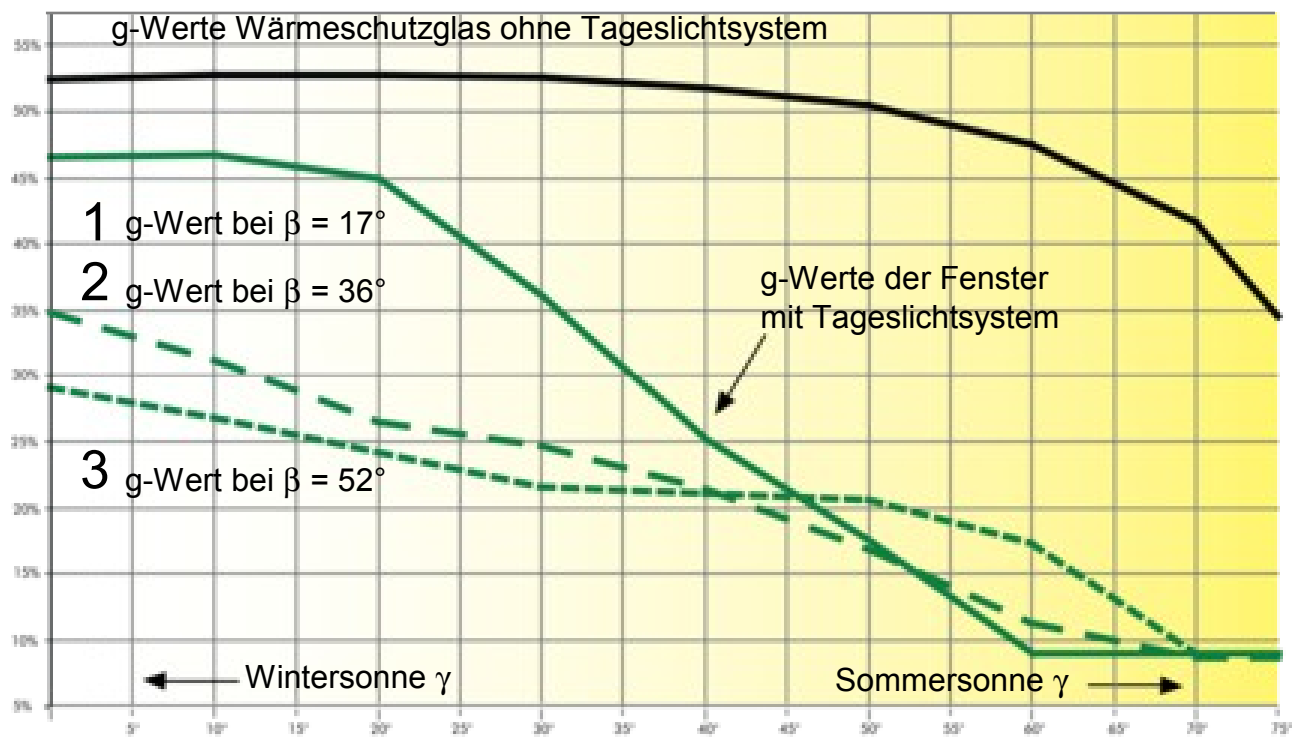



Haus der Technik,  
Wien, Sensengasse  
Architekten:  
Neumann + Partner  
und Mascha &  
Seethaler, Wien  
Tageslicht:  
Köster Lichtplanung

# Durchsicht

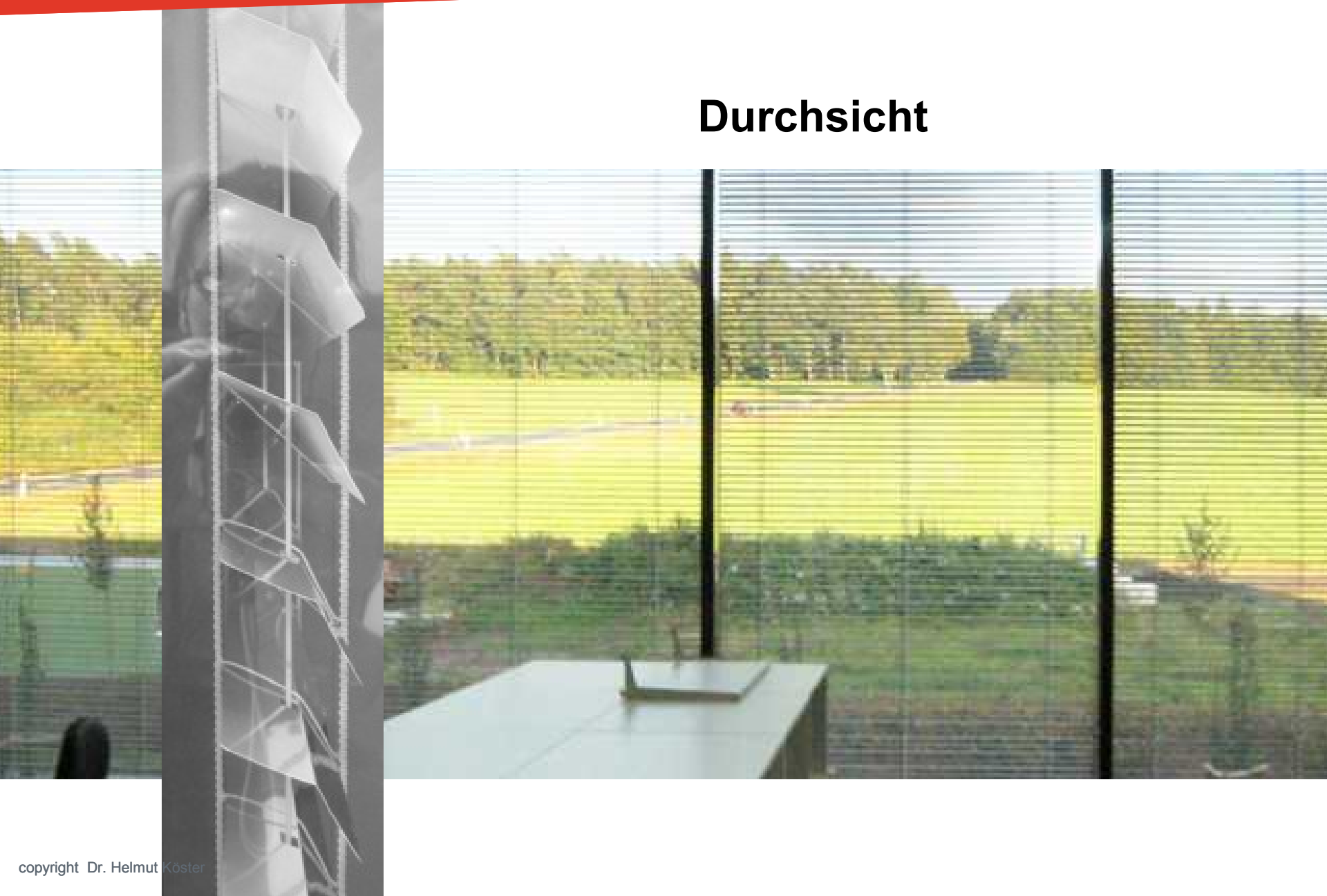

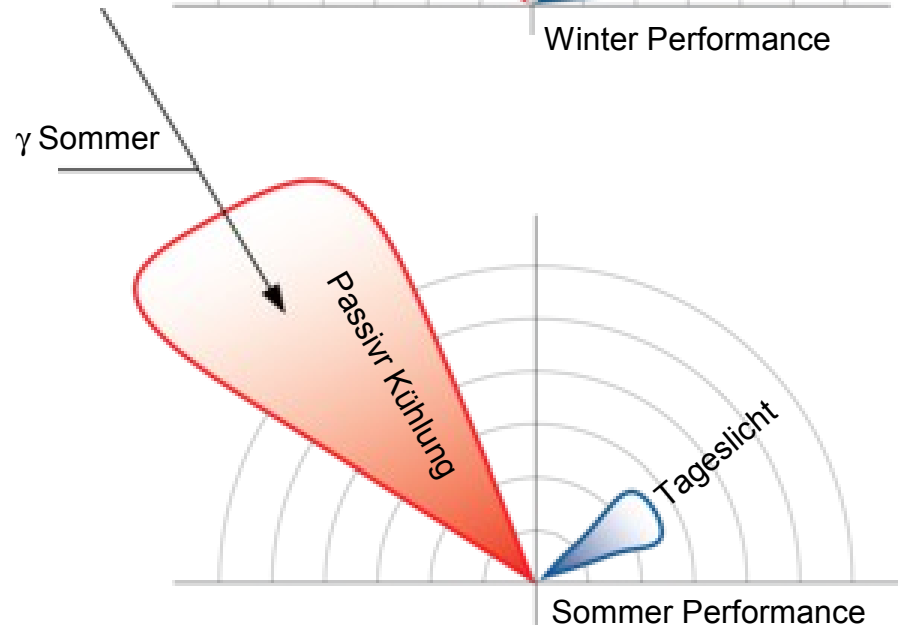
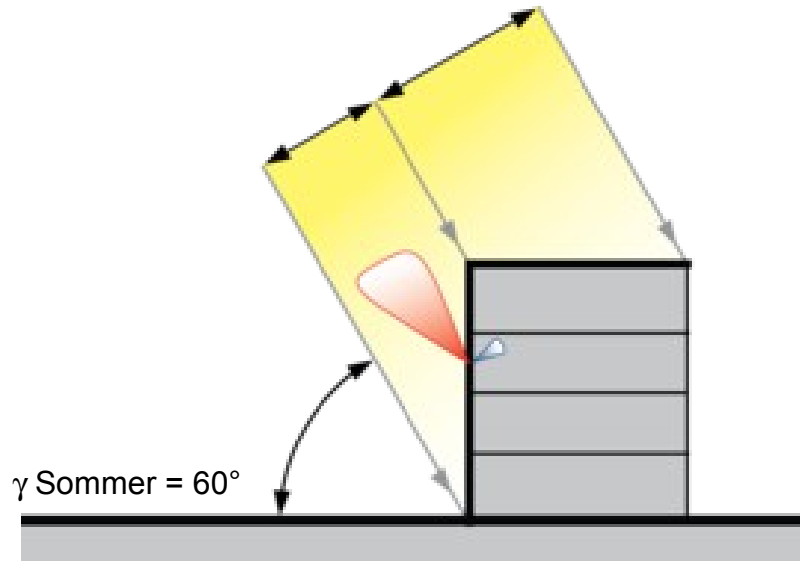
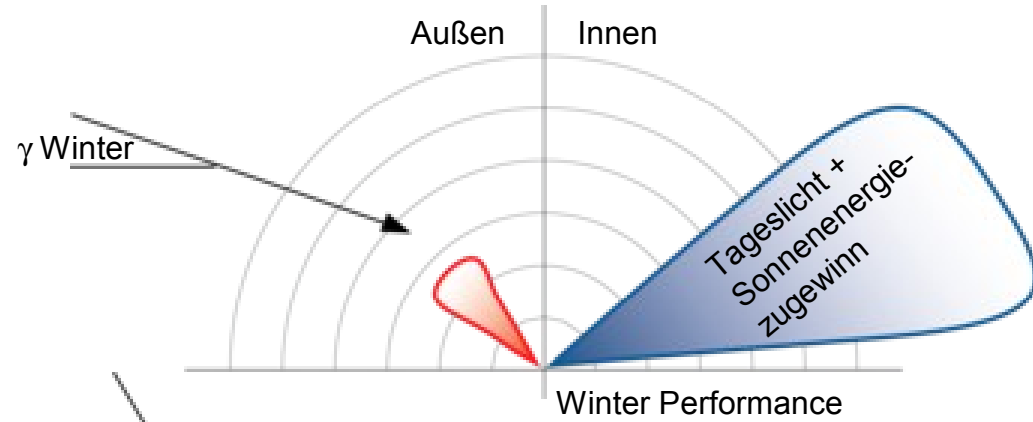
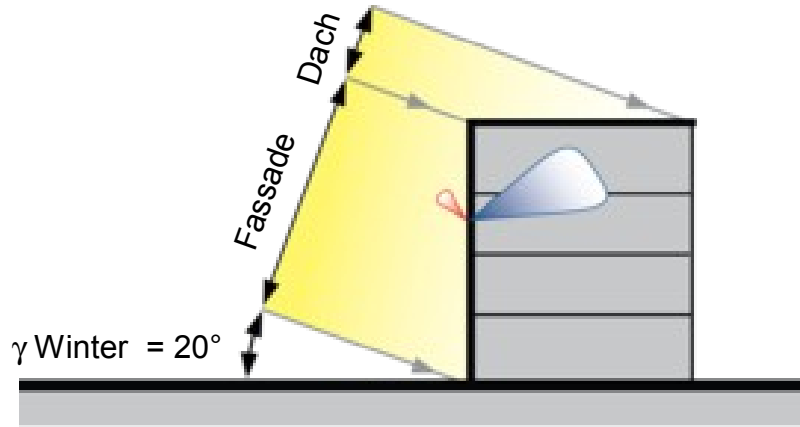

# Tageslicht und visueller Komfort

Tageslichtquotient  $D = E_i / E_a \times 100\%$

$E_i$  = Innenbeleuchtungsstärke [lx]

$E_a$  = Außenbeleuchtungsstärke [lx]

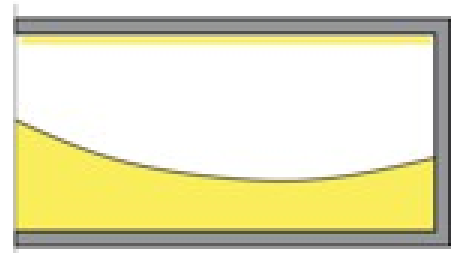
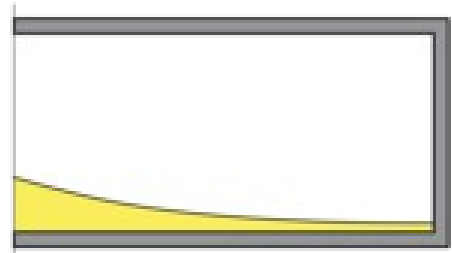
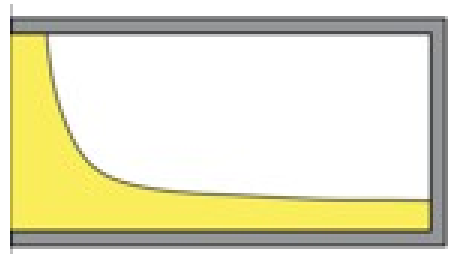

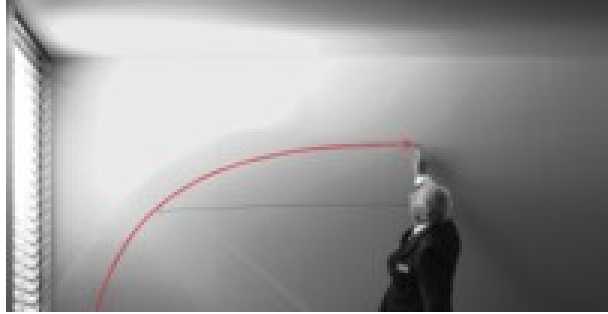

# Blendfreie Lichtführung

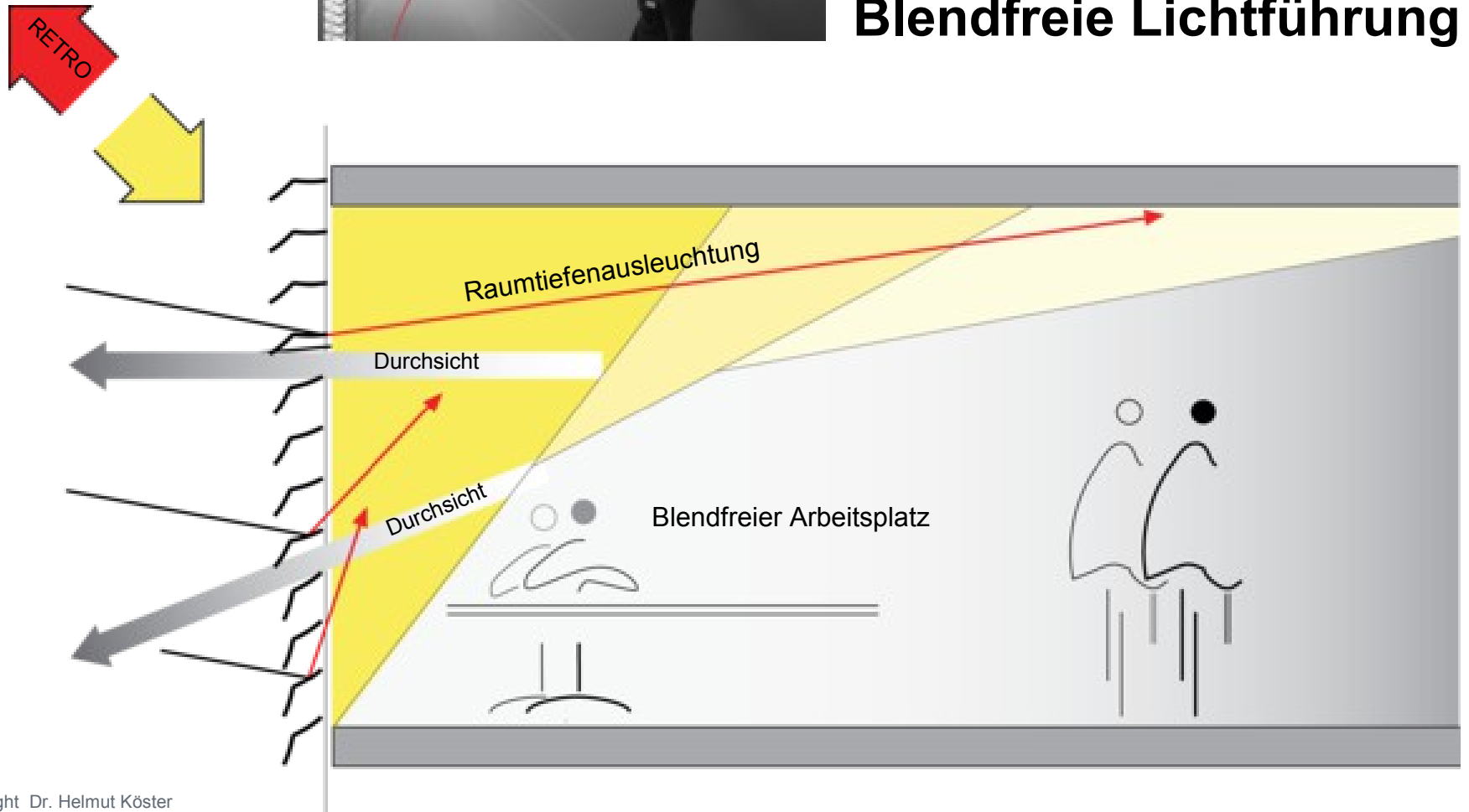

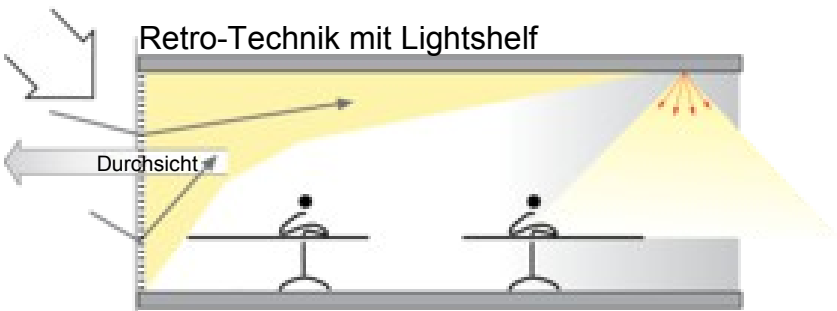
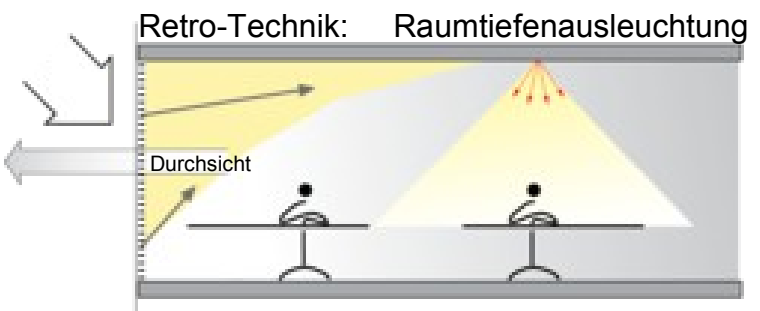
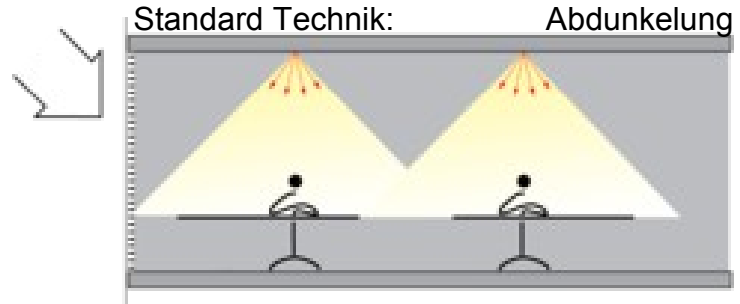

# Tageslichtautonomie: Einsparung elektrischer Beleuchtung

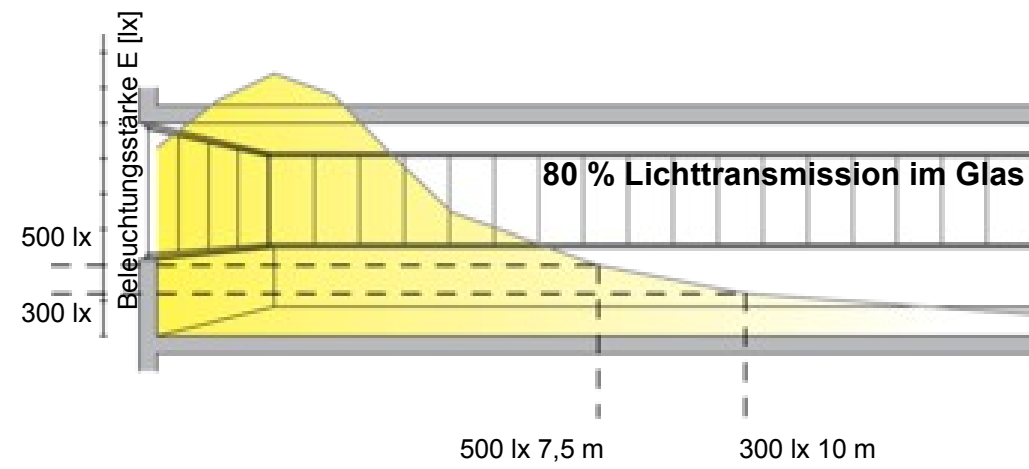

## Zweischalige Fassade mit RETROLux A



RETROLux A in zweischaliger Fassade,  
Postverteilerzentrum Wädenswil, CH  
Architect: HZDS, Heinz Zimmermann





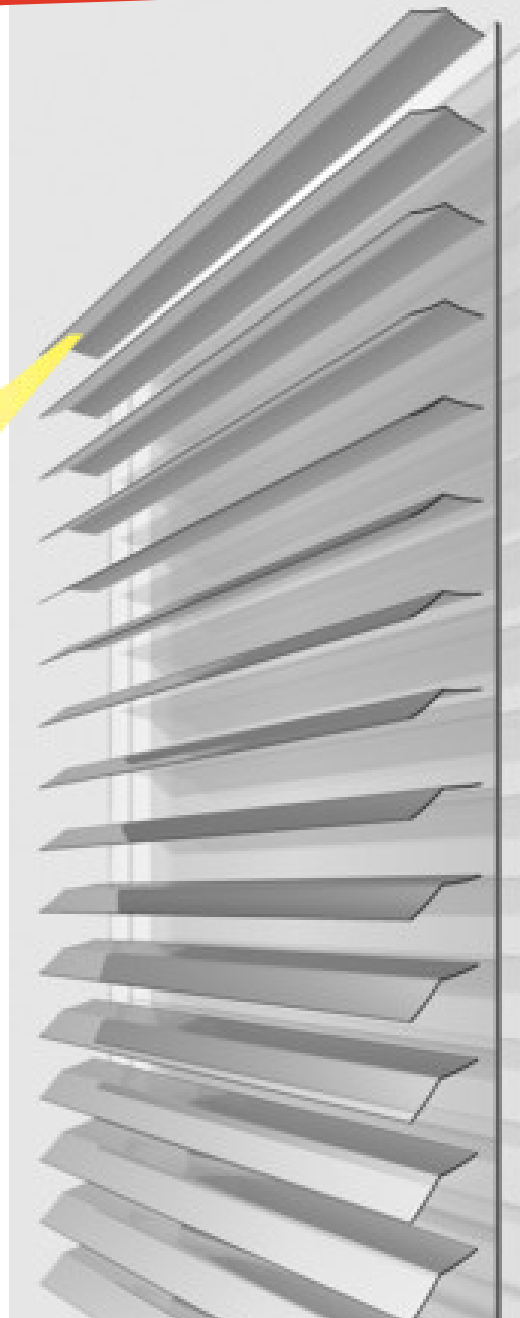
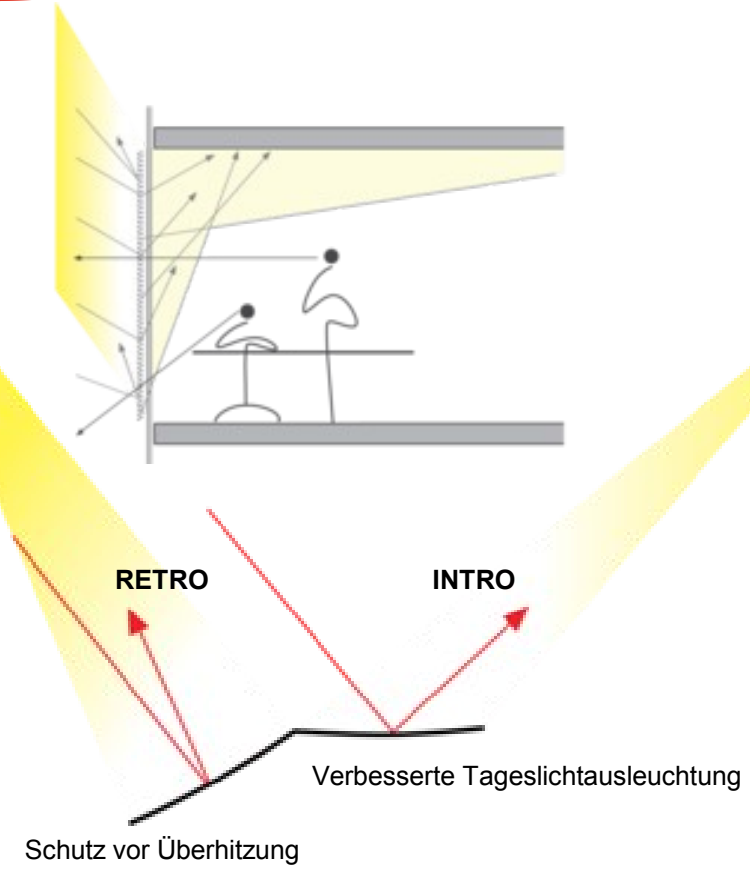
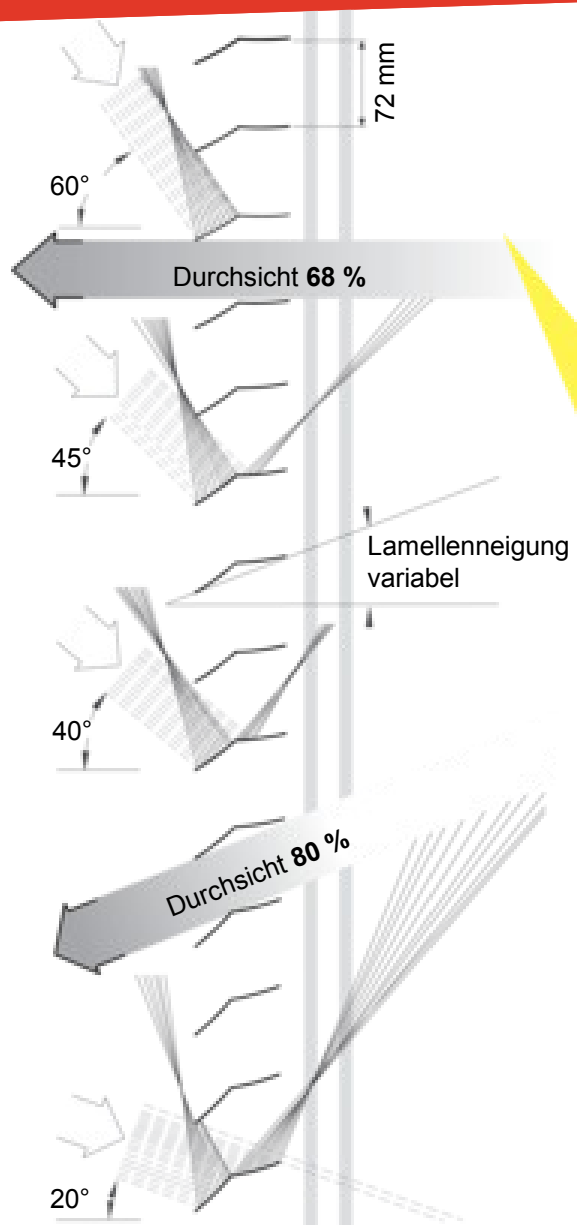



RETROLux A in zweischaliger Fassade,  
Postverteilerzentrum Wädenswil, CH  
Architekt: HZDS, Heinz Zimmermann



# RETROLux

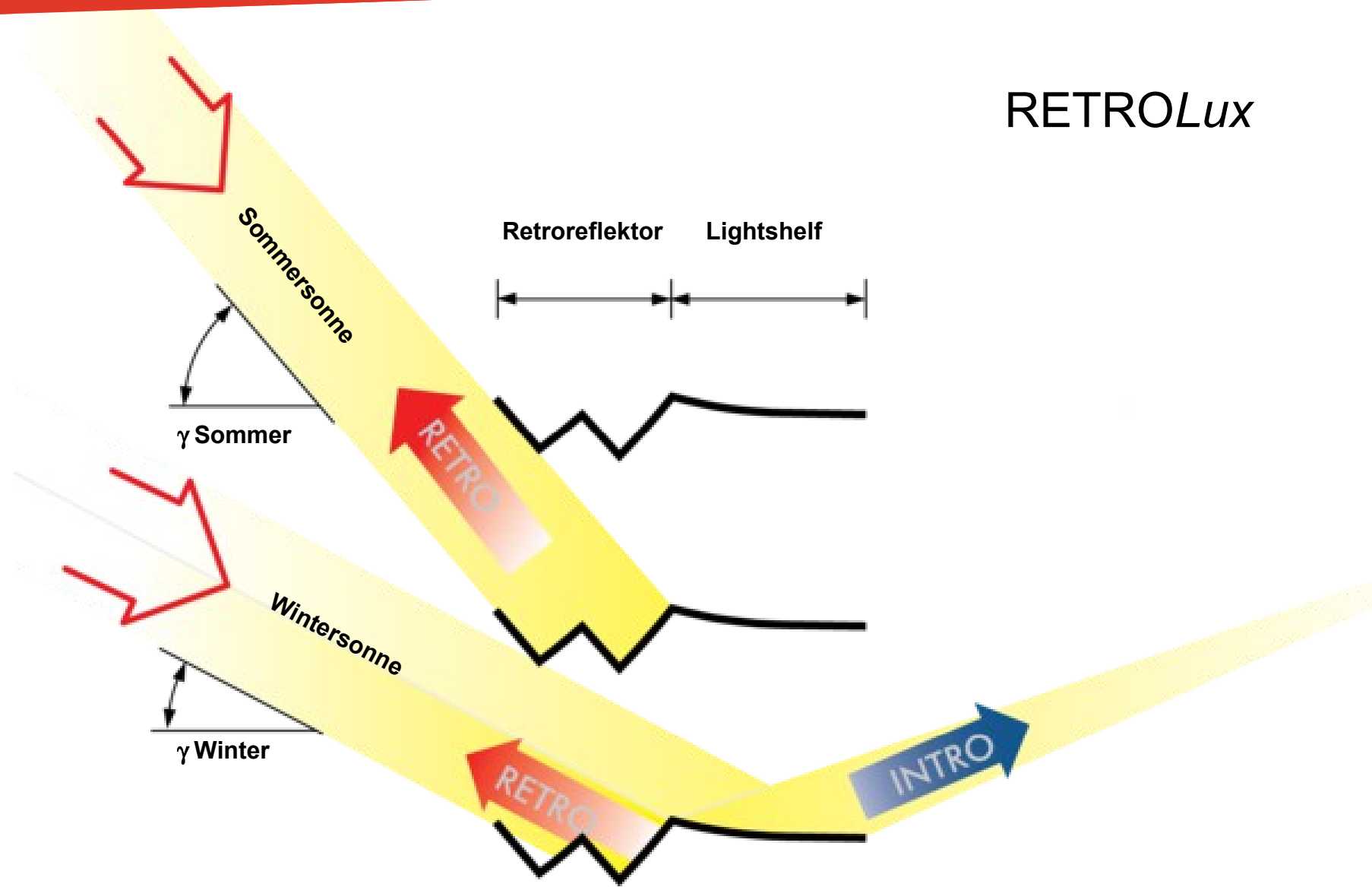

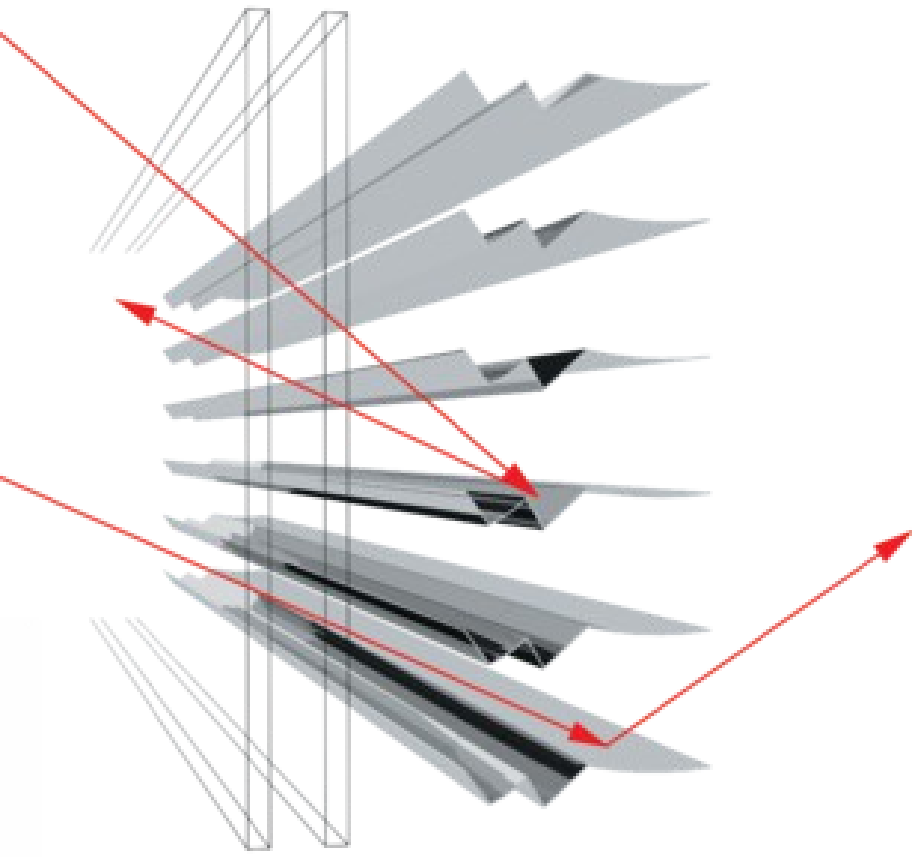

# RETROLux

## Dynamischer g-Wert

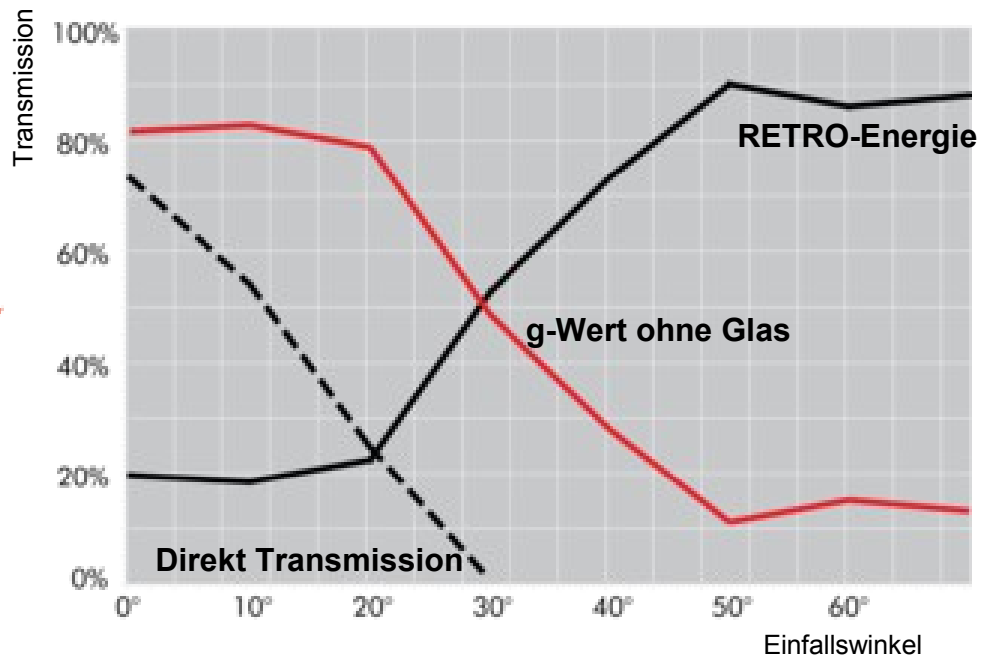

# Flash animation folded blind

# Durchsicht von RETROLux Lamellen

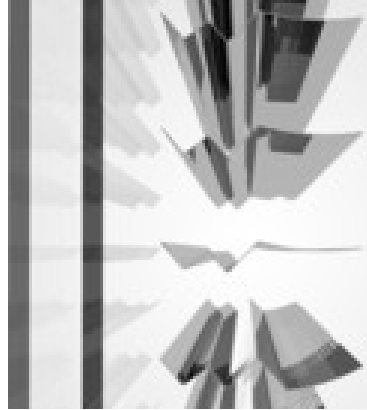

Fa. Grenzebach, Bad Hersfeld,  
Arch.: Stefan Wehner, Bad Hersfeld



Kassenärztliche Vereinigung, Dortmund  
Architekten: SSP, Schürmann Spannel AG, Bochum



Gleichzeitig:

Passive Kühlung  
Tageslicht  
Durchsicht

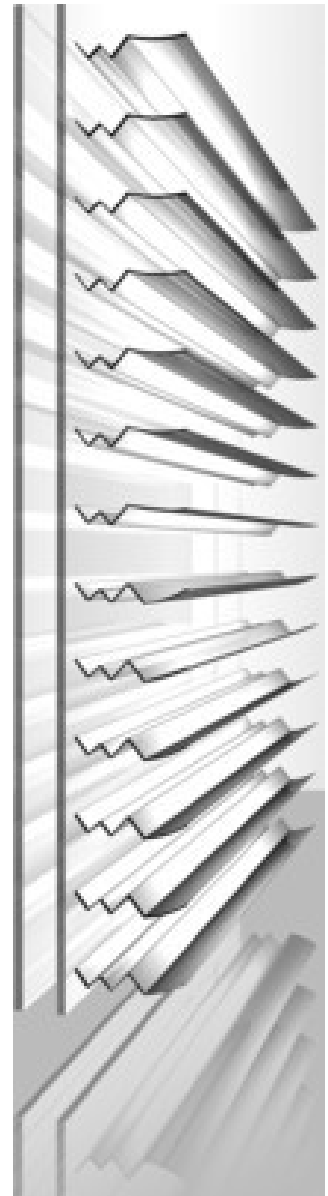
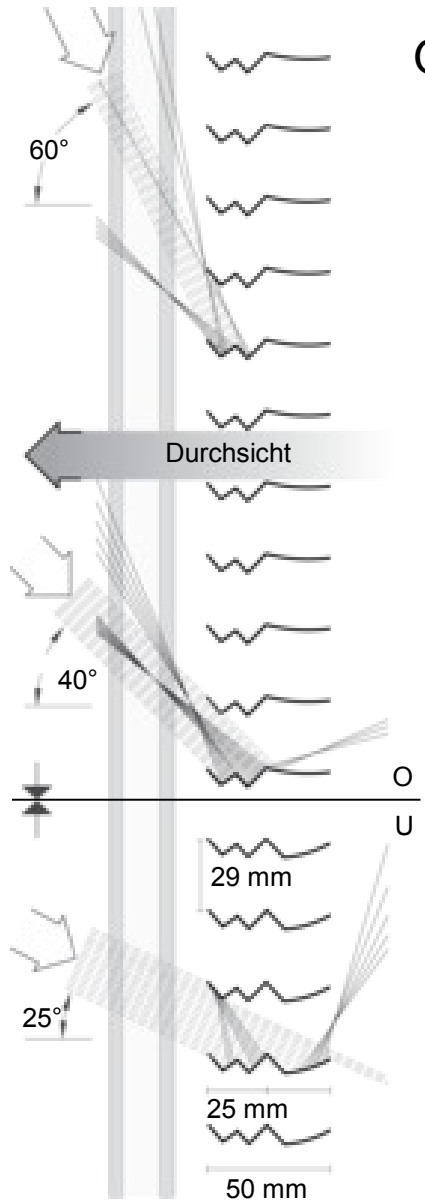



Gleichzeitig:

Passive Kühlung  
Tageslicht  
Durchsicht

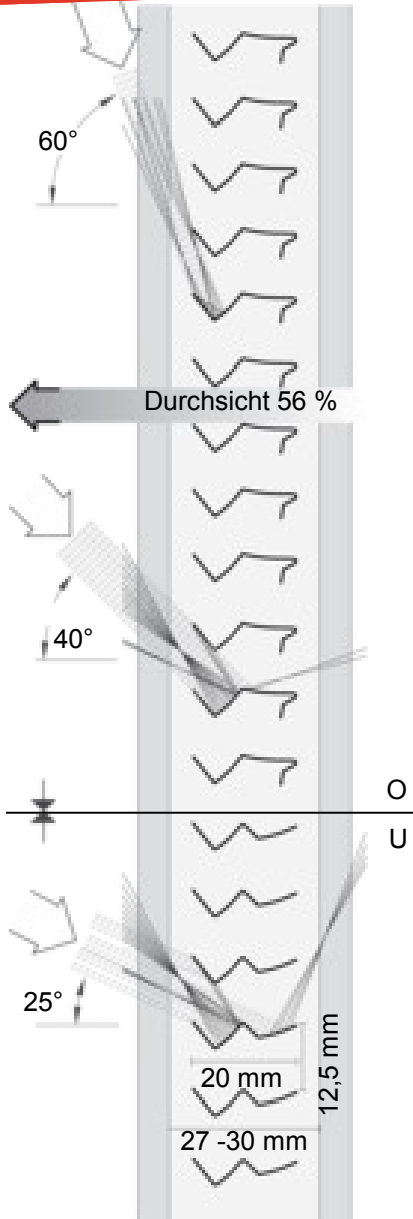

Landesdenkmalamt Baden-Württemberg, Esslingen; Arch.: Odilo Reuter, Esslingen

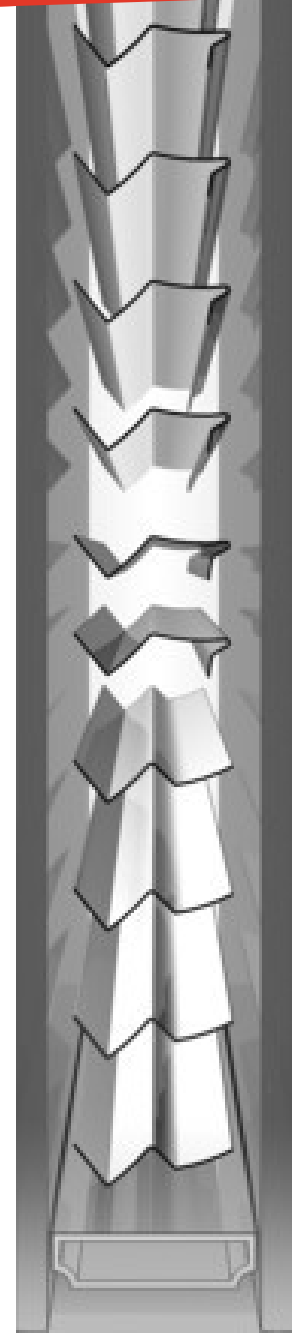



Audi-Max und Mensa der FH-Giessen.





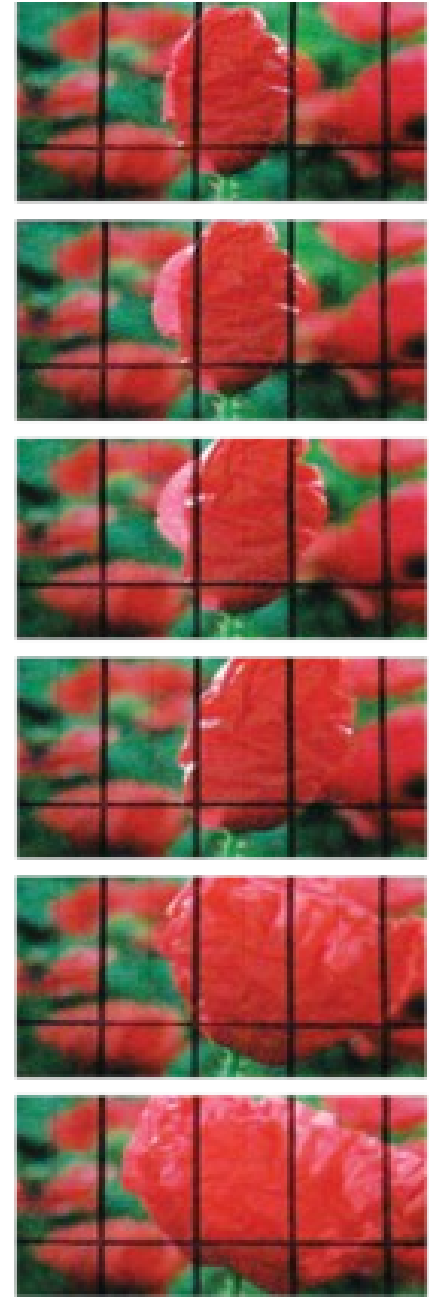
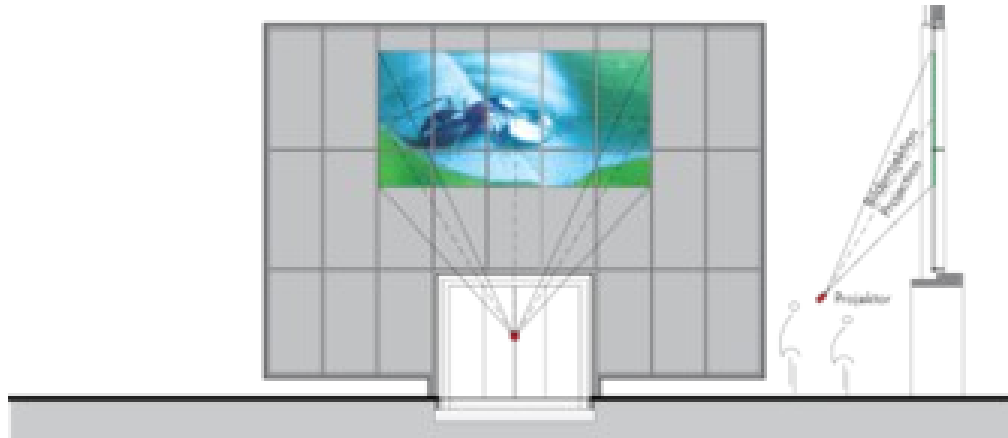
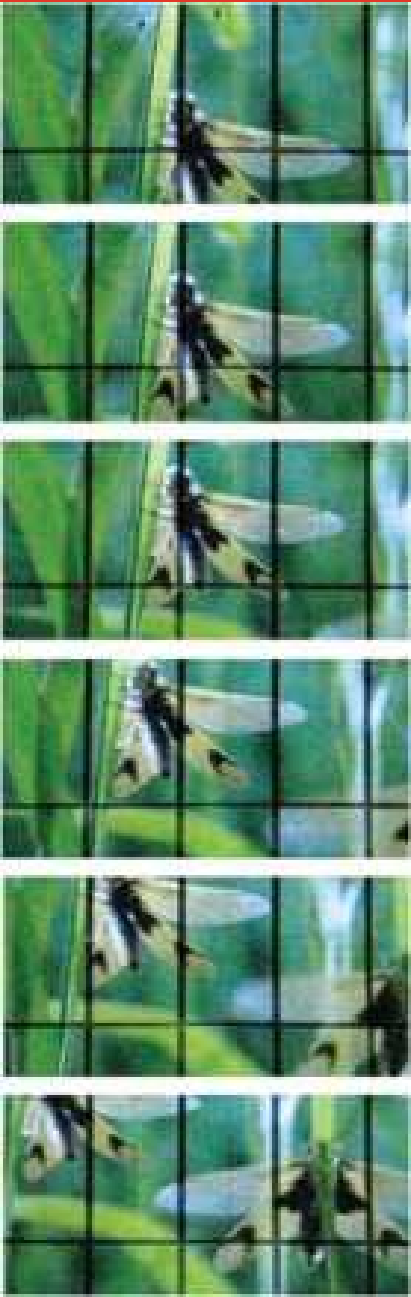



Sonnenschutzposition



Abdunkelungsposition



Die Hauptverwaltung der SCHOTT AG in Mainz wurde mit einer Verglasung des Typs 66/32 und innenliegenden RETROLux-Jalousien ausgestattet. Die Innenaufnahmen zeigen die hervorragende Durchsicht bei aktivem Sonnenschutz.



## Optische Eigenschaften monoreflektiver Retro-Systeme Typ „Makro“ (RETROLux)

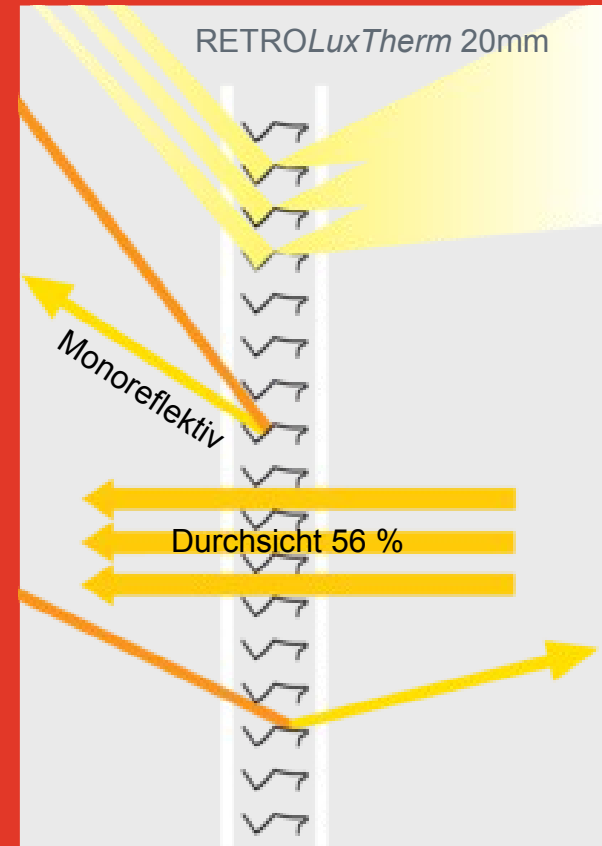
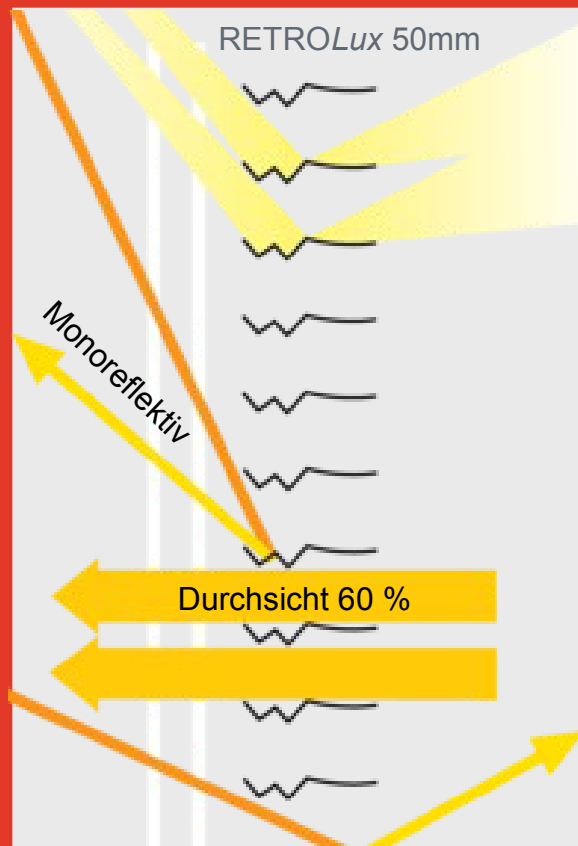
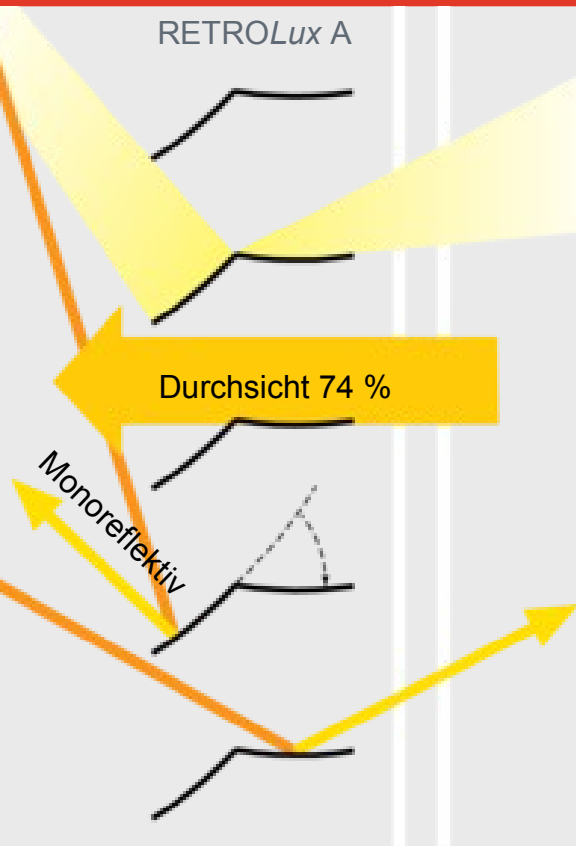

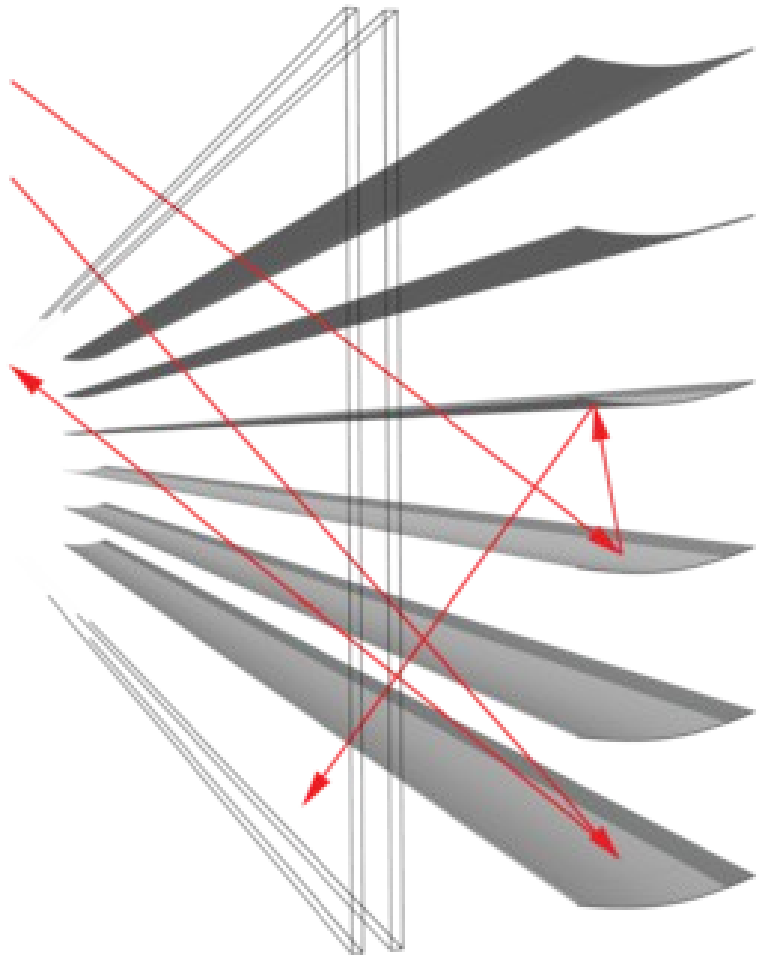

# RETROFlex

## Dynamischer g-Wert

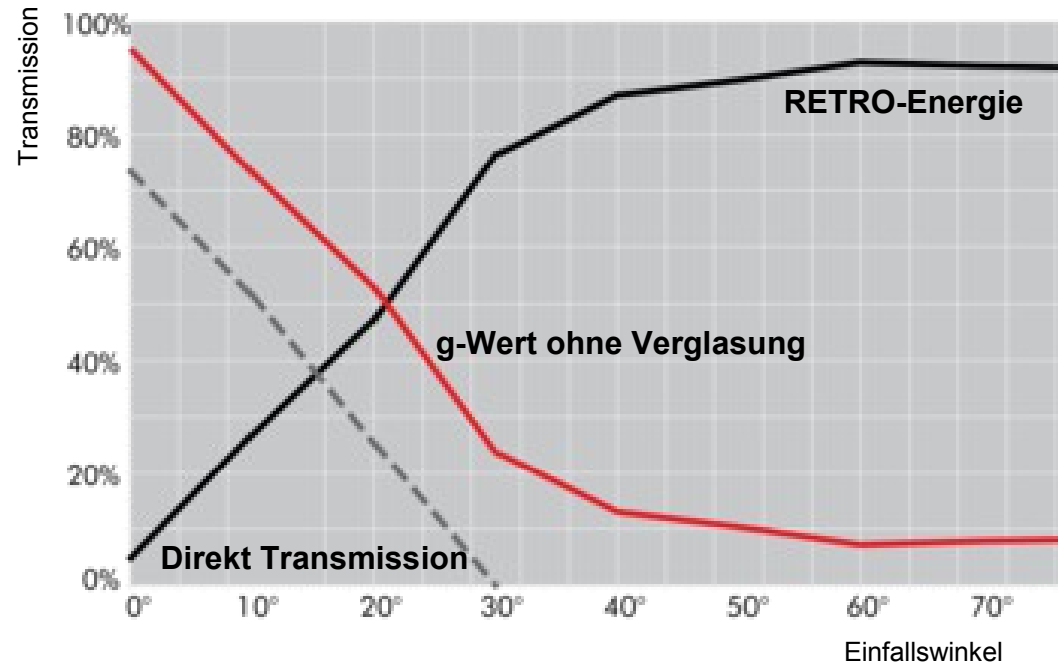

# RETRO-Lamelle Typ „Mikro“ (RETROFlex) mit Fresnel-Optik

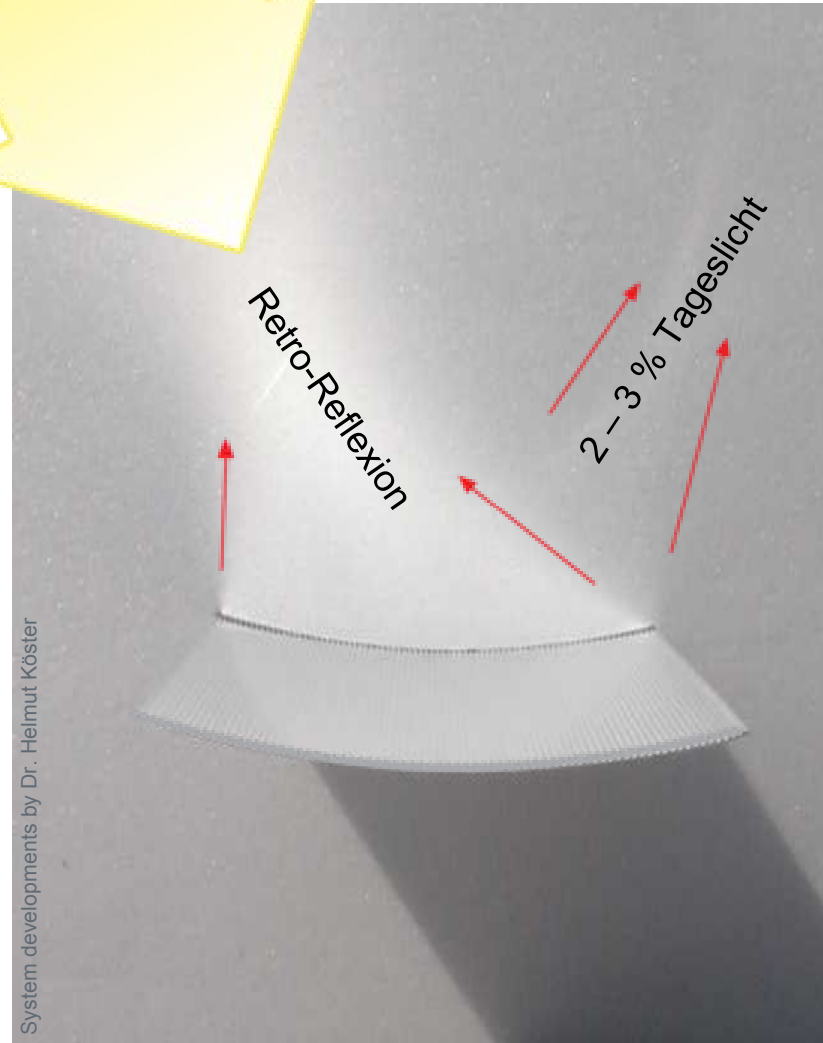
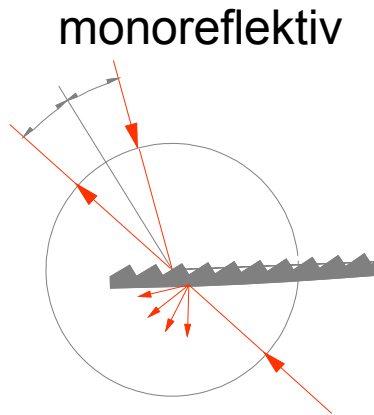
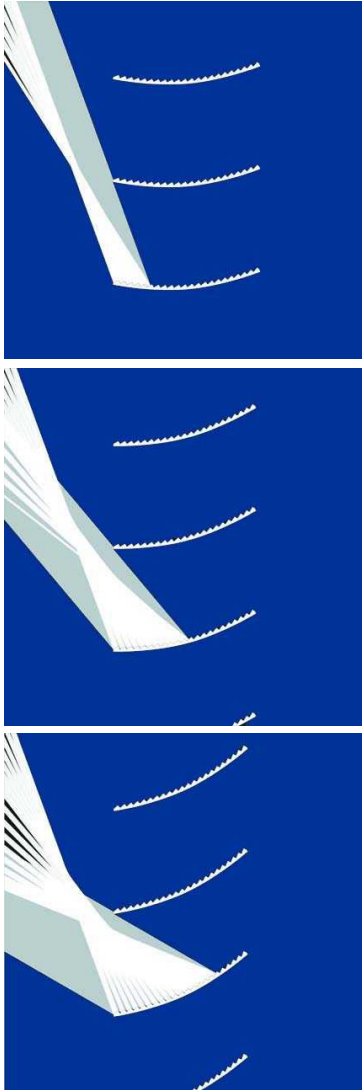



# Flash animation micro structured blind

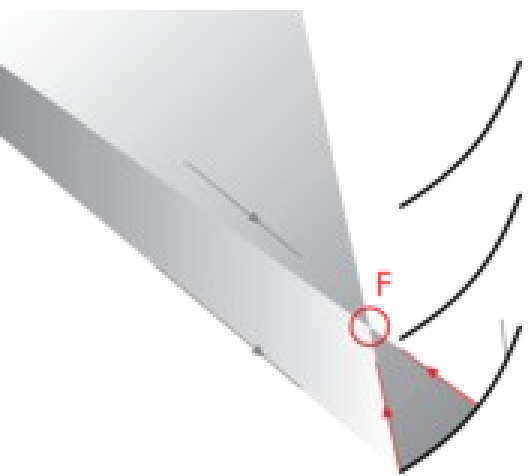

Alter Stand der Technik  
Spiegellamellen:  
Behang geschlossen,  
Durchsicht verhindert,  
keine Tageslichtausleuchtung

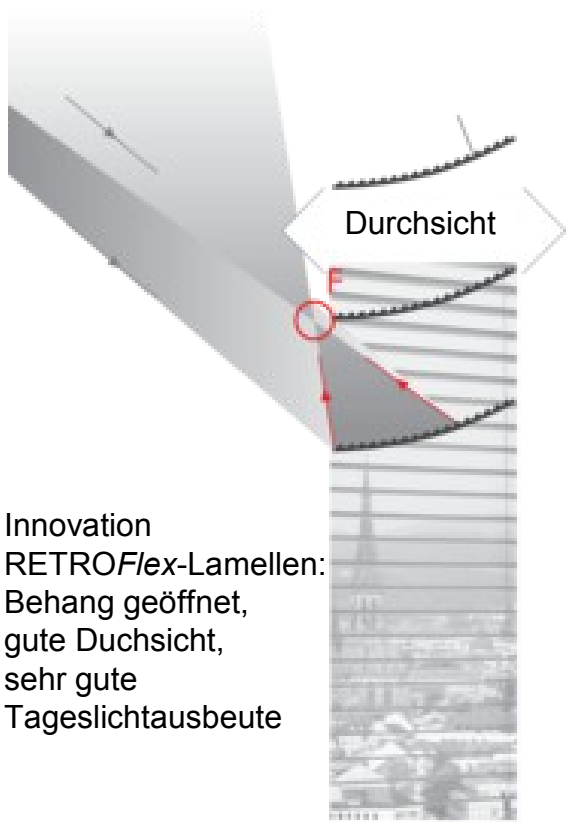

Innovation  
RETROflex-Lamellen:  
Behang geöffnet,  
gute Durchsicht,  
sehr gute  
Tageslichtausbeute

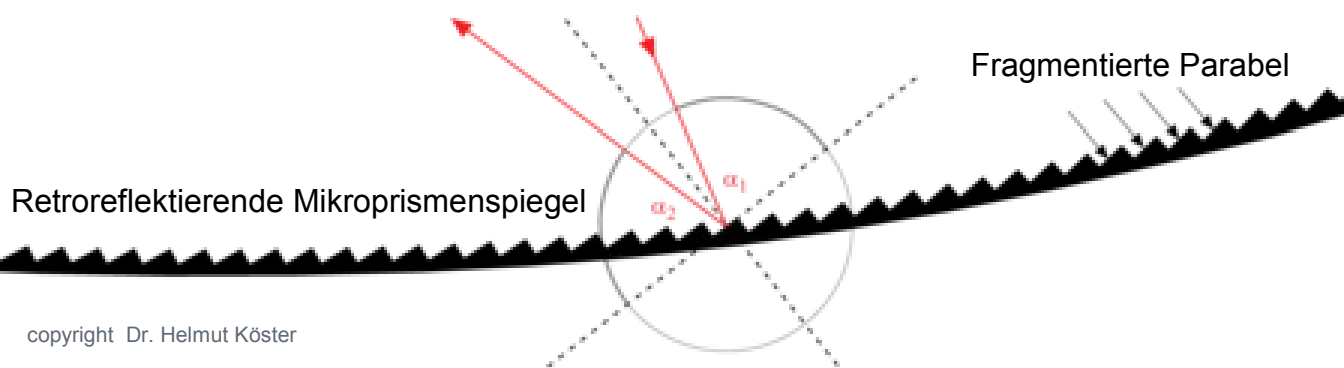
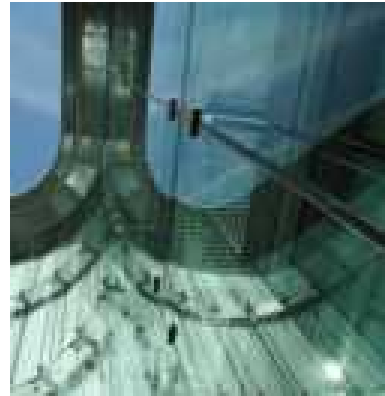

# RETROFlex

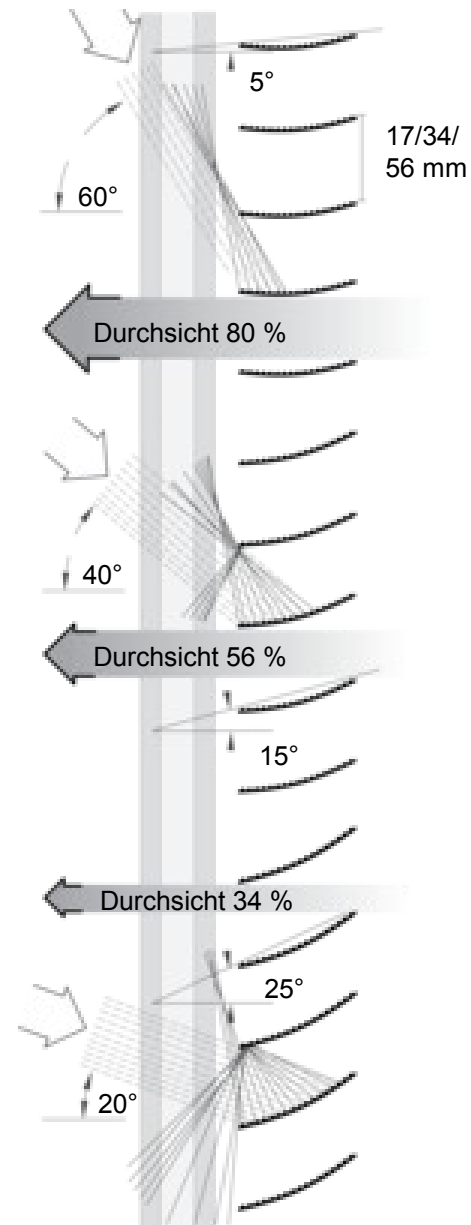
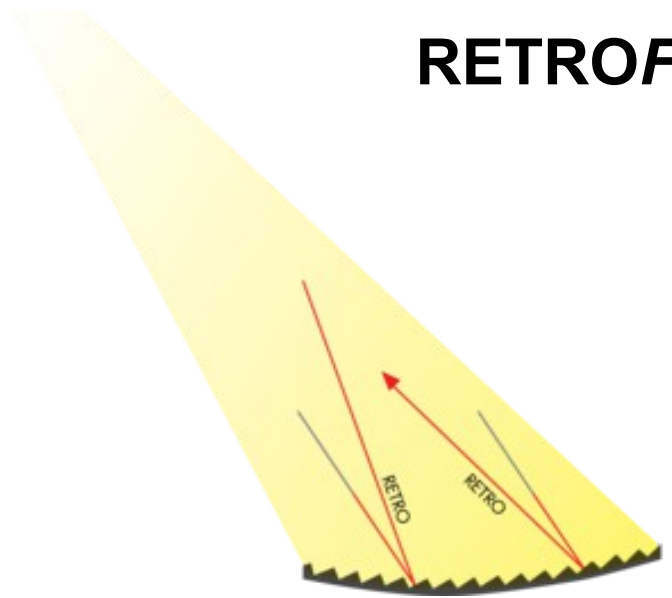
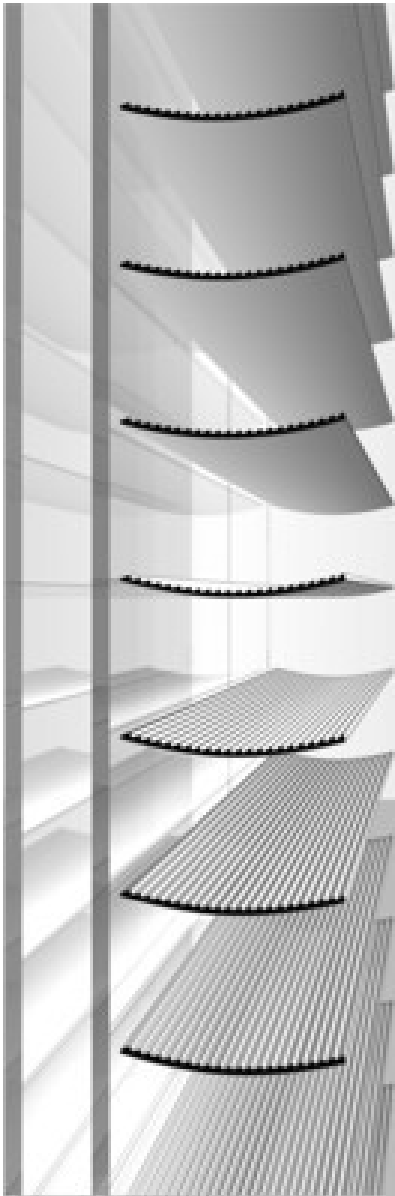

# Hinterlüftete, zweischalige Fassade mit Fresnel-Spiegeln (RETROflex 80mm)

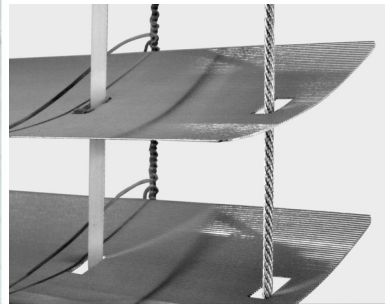

Mobimo Hochhaus, Zürich, Arch. Heinz Zimmermann, Rolf Läubli, Zürich

# RETROFlex in zweischaliger Fassade

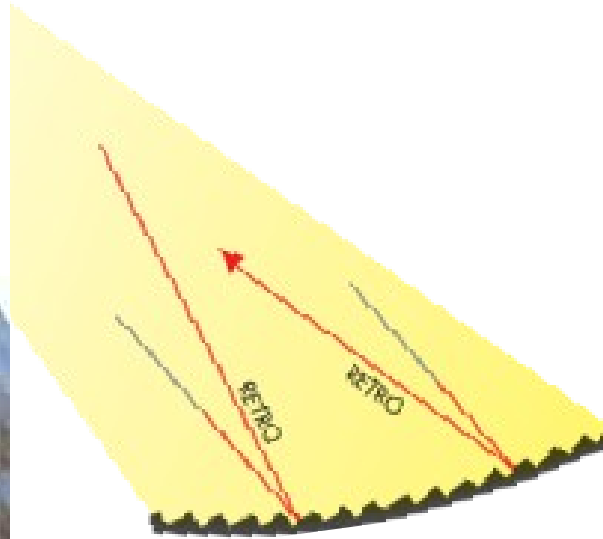

# Nicht-hinterlüftete, zweischalige Fassade mit Fresnel-Optik (RETROflex 80mm)

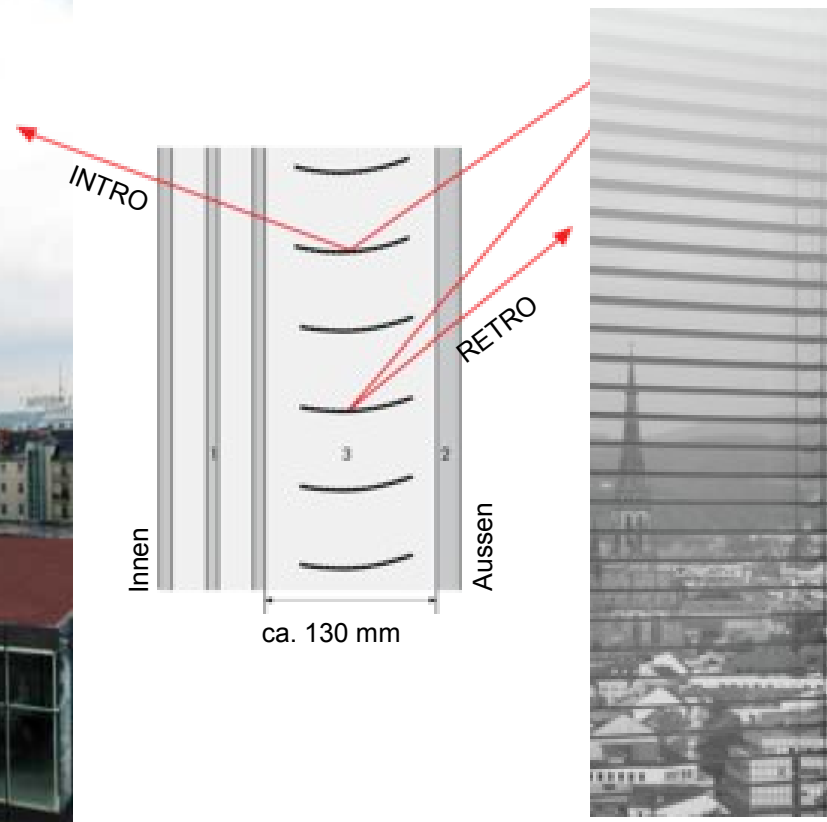

# Nicht-hinterlüftete, zweischalige Fassade mit Fresnel-Optik



Oberösterreichische Energie AG,  
Linz, Arch. Kaufmann + Partner,  
Entwurf: Arch. Hofer Zürich

copyright Dr. Helmut Köster

U-Wert = 0,55 W/m<sup>2</sup>K  
Dreischeibenverglasung innen  
g = 0,05 – 0,1

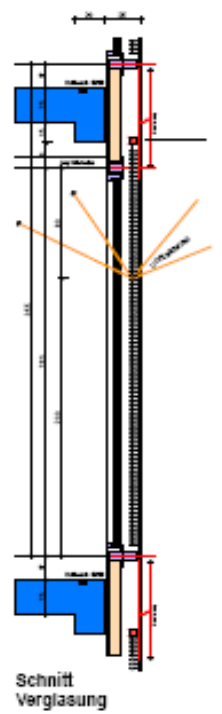

# Verbundfenster

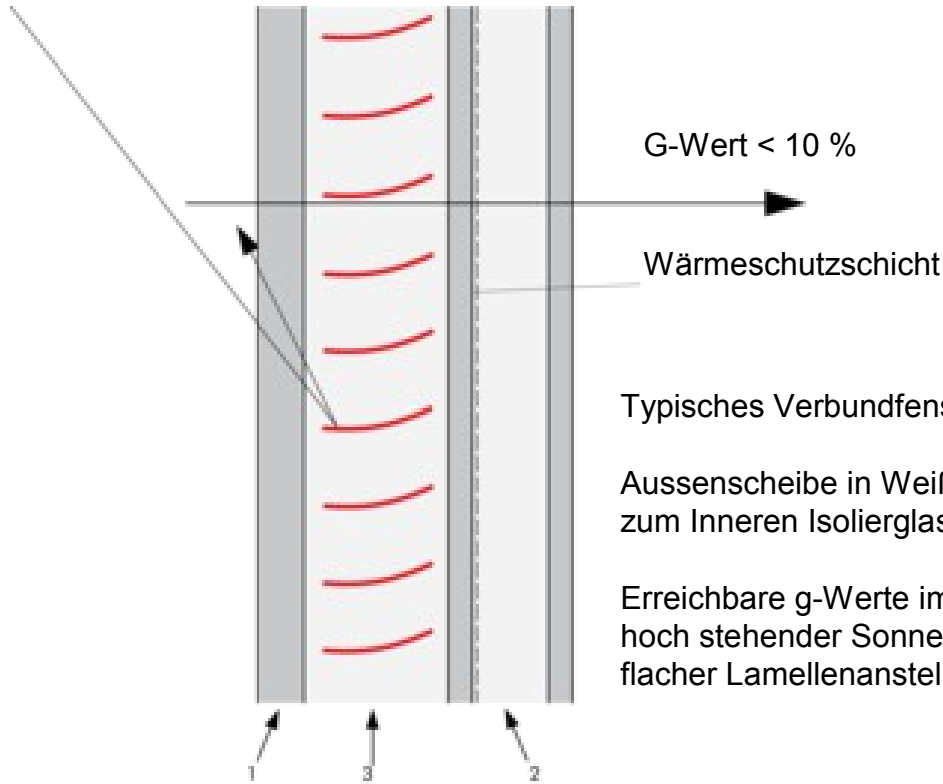

Typisches Verbundfenster

Aussenscheibe in Weißglas (1),  
zum Inneren Isolierglas (2).

Erreichbare g-Werte im Sommer bei  
hoch stehender Sonne und  
flacher Lamellenanstellung: < 10 %





# Zweischalige Fassade, nicht hinterlüftet

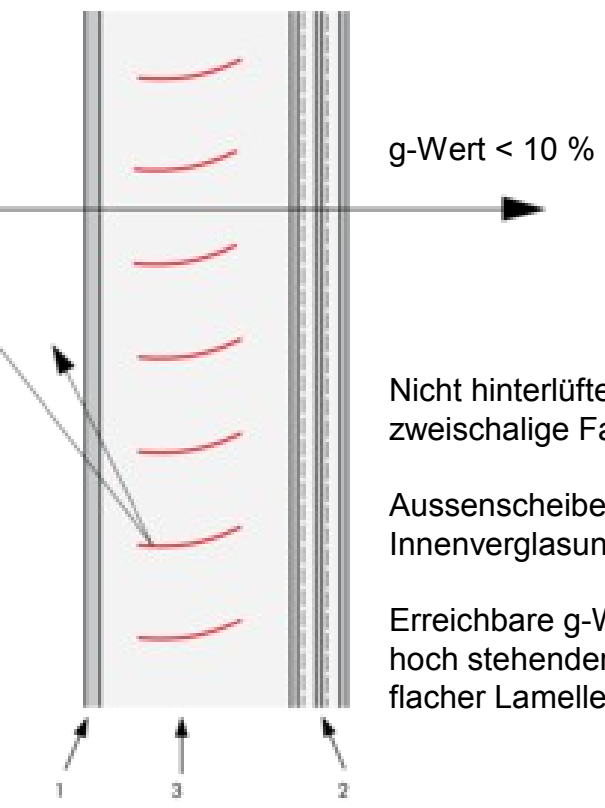

g-Wert < 10 %

Nicht hinterlüftete,  
zweischalige Fassade

Aussenscheibe in Weißglas (1),  
Innenverglasung in 3-Scheiben Isolierglas (2)

Erreichbare g-Werte im Sommer bei  
hoch stehender Sonne und  
flacher Lamellenanstellung : < 5 %

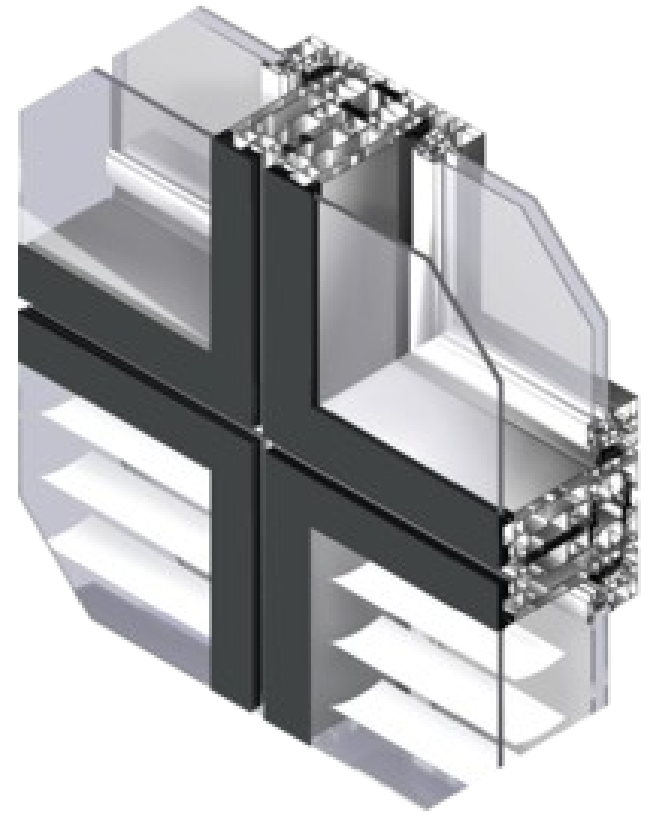

# Nicht-hinterlüftete, zweischalige Fassade mit Fresnel-Optik (RETROFlex 80mm)



Sopharma und Litec Building Sofia, Bulgarien  
Arch. Paskalev, Sofia Bulgarien

copyright Dr. Helmut Köster

U-Wert = 1,1 W/m<sup>2</sup>K  
g = 0,05 – 0,1

# Nicht-hinterlüftete, zweischalige Fassade mit Fresnel-Optiken (RETROFlex 80mm)

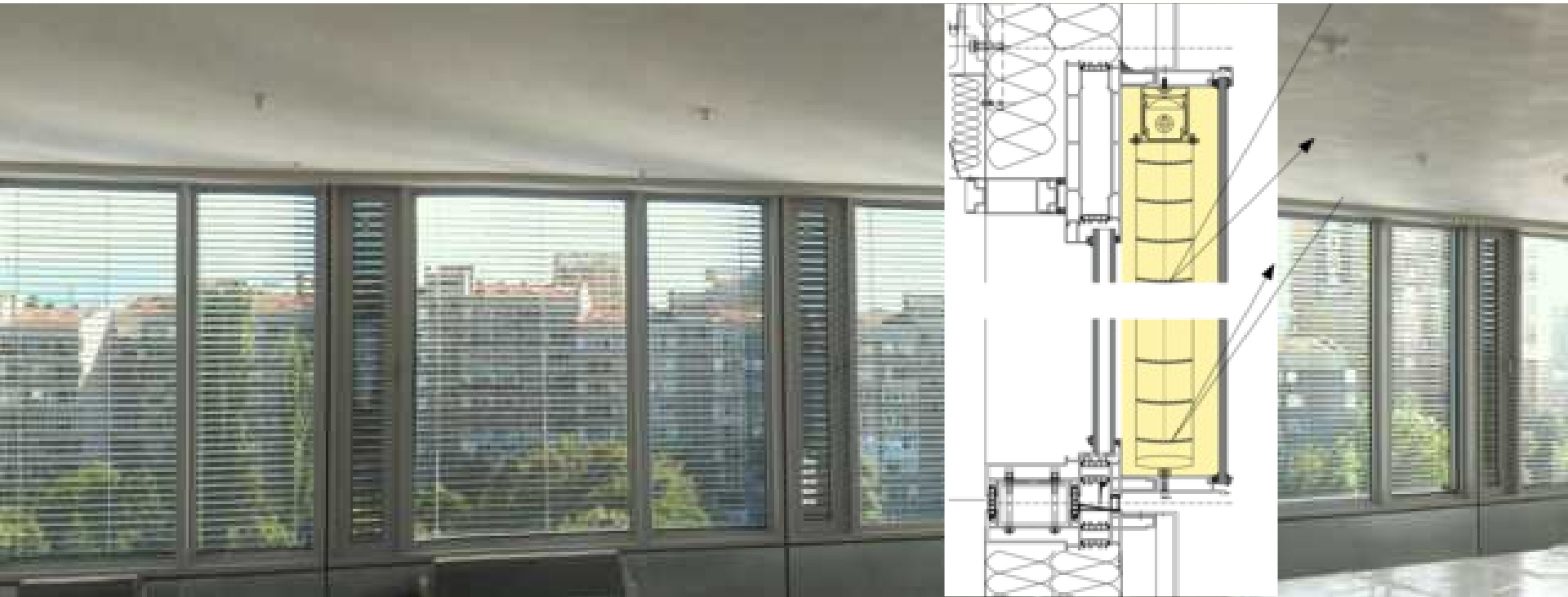



Standard Bank of South Africa, Johannesburg

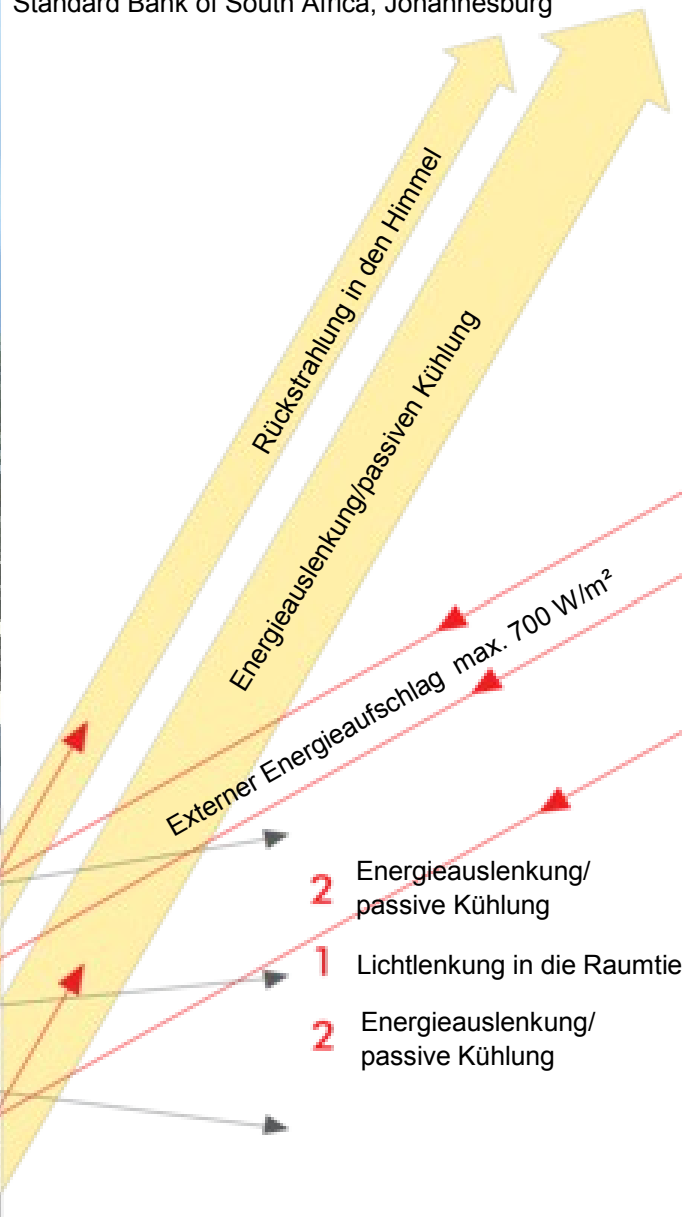
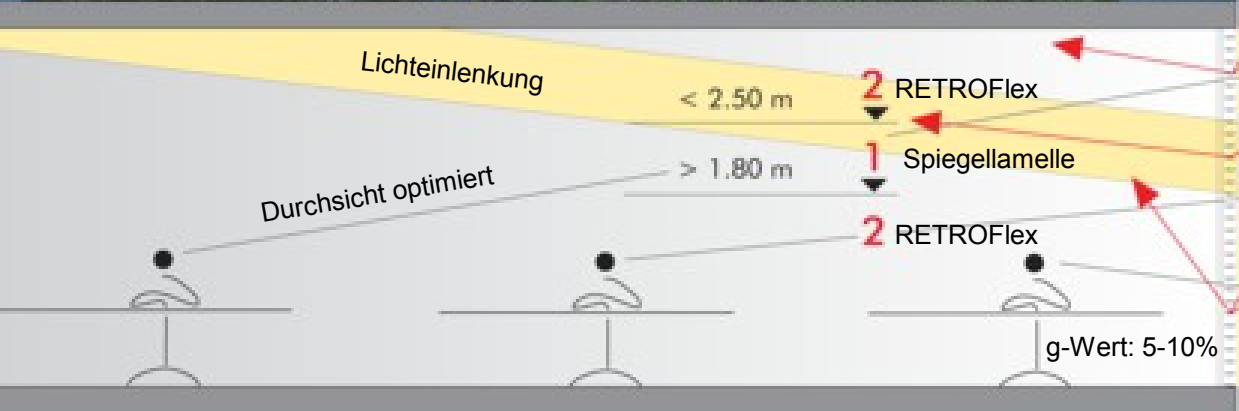



Spiegeloberfläche  
 weiße Unterseite

1

Lichtumlenkung zur besseren Tageslichtausleuchtung

Wechsel von Spiegellamelle/  
 RETROFlex

1.80 m OKF

Fresnel-Spiegel  
 2

weiße Unterseite

RETRO-Reflexion

Lamellenkippwinkel -5°  
 Lamellenkippwinkel 5°

INTRO zur Raumausleuchtung

RETRO zur passiven Kühlung

1

2



Standard Bank of South Africa, Johannesburg

# RETROFlex Therm

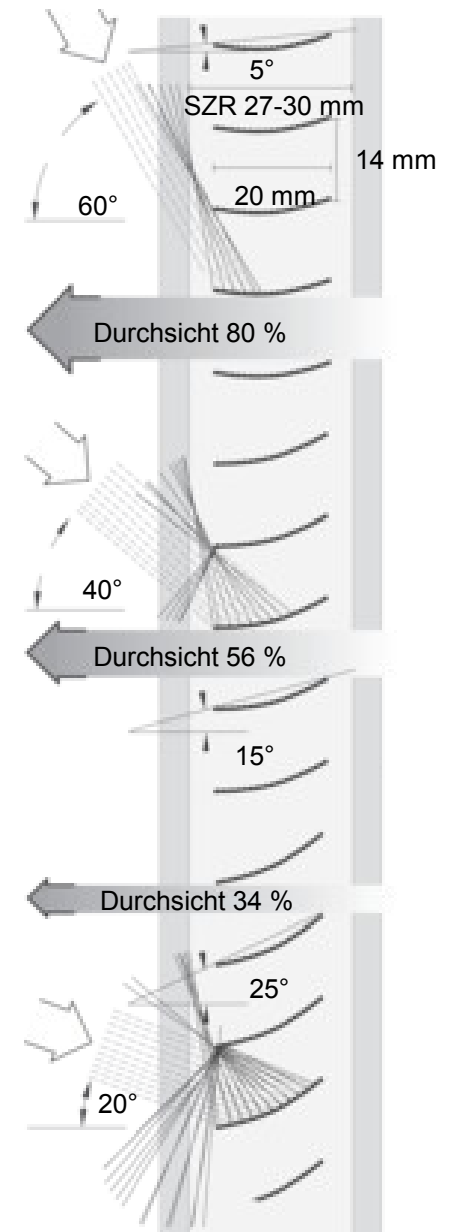
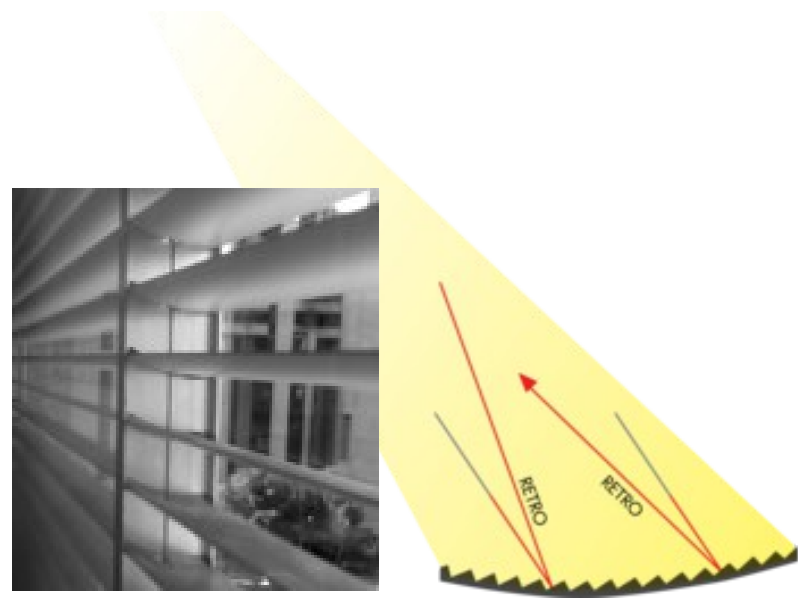
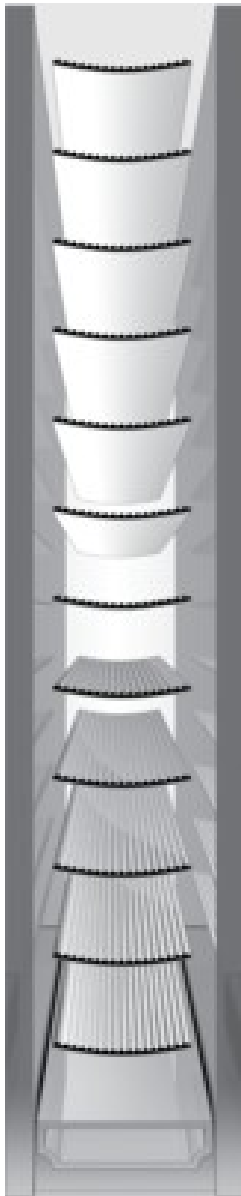



# RETROflex im Dach

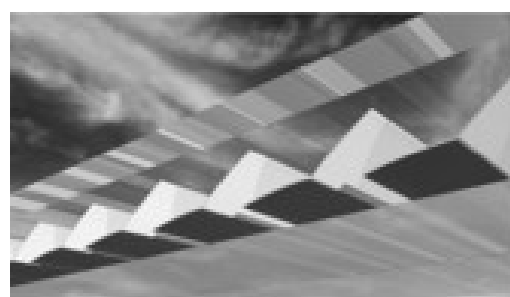
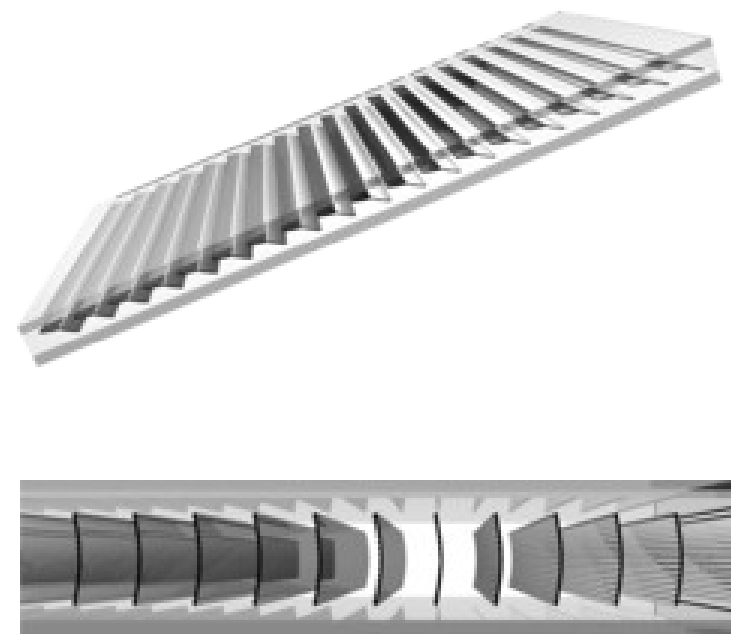



Central Bank of Kuwait  
Architekten: HOK, London





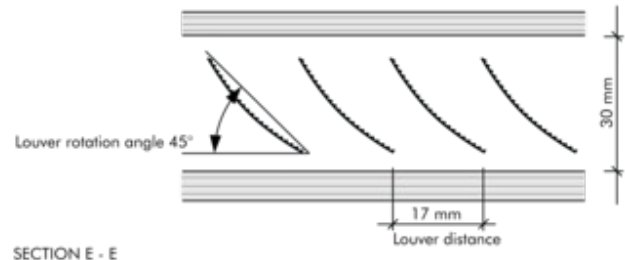
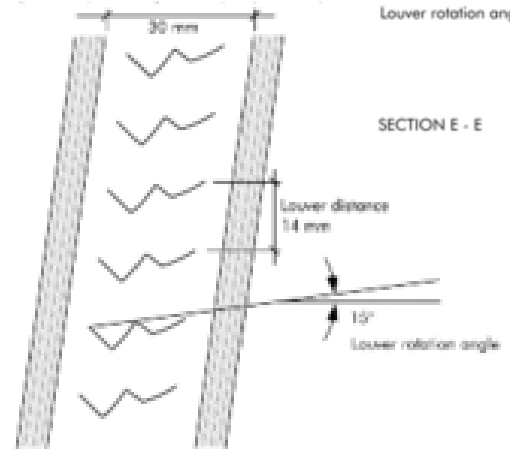
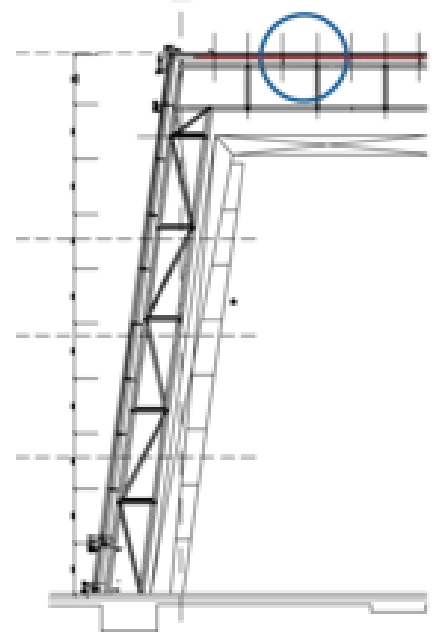
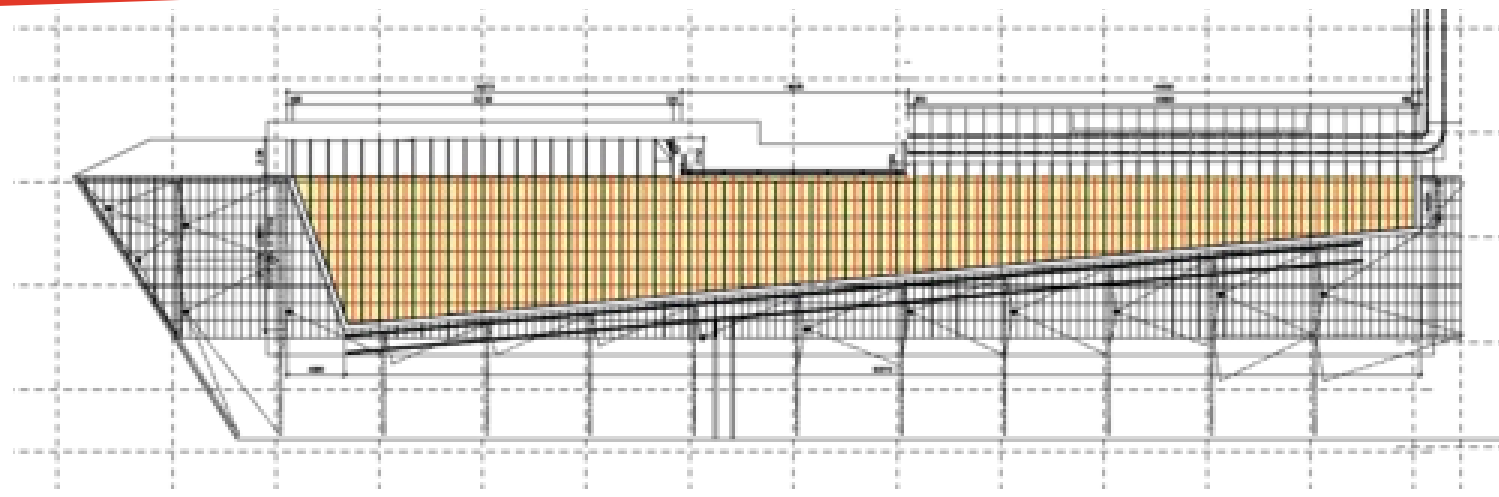

# Ziel der Tageslichttechnik:

- Verminderung der Kühllast durch Retro-Reflexion
- Verminderung des Stromverbrauchs durch verbesserte Tageslichtautonomie



Energie AG, Linz

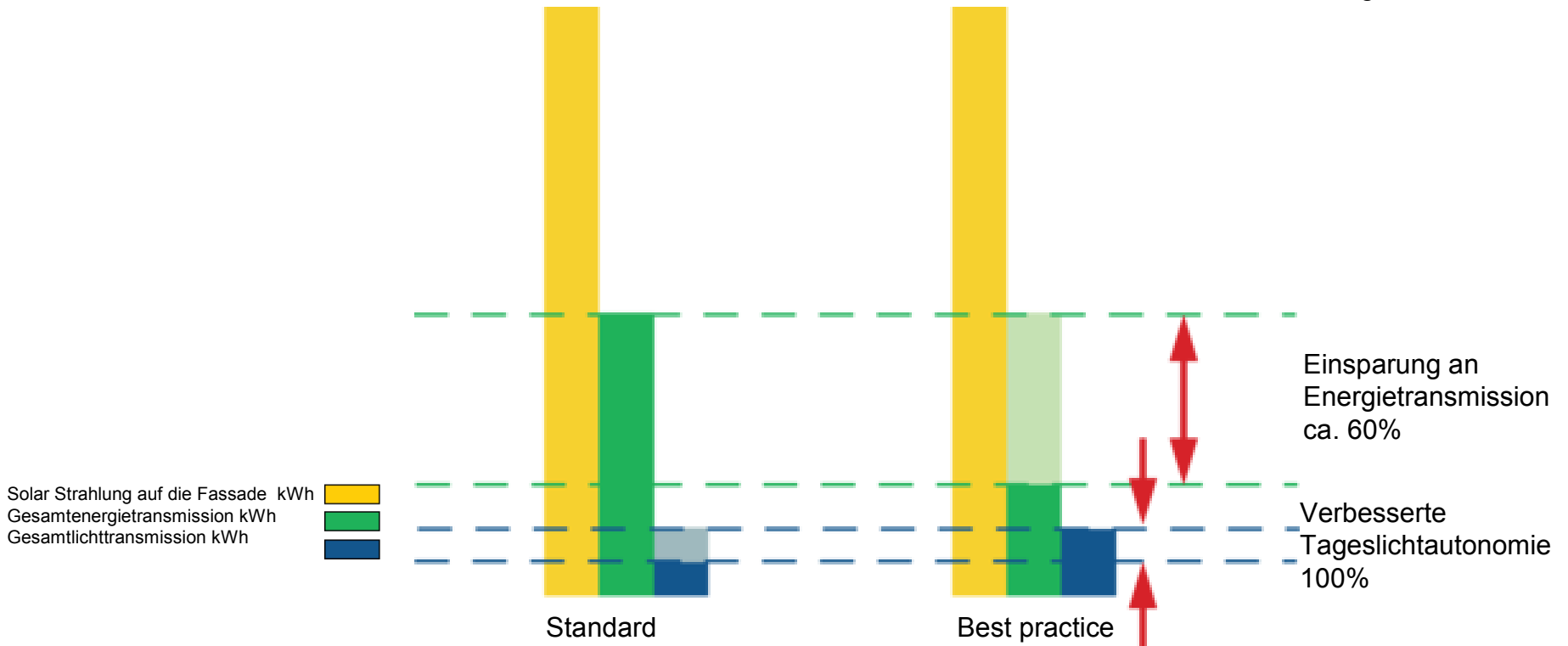

# Energieeinsparung durch Tageslicht und reduzierte Kühllasten

Stand der Technik  
WSV +Innenjalousie

Best practice  
mit Mehrfachverglasung  
u. integrierter Lichtlenkung.

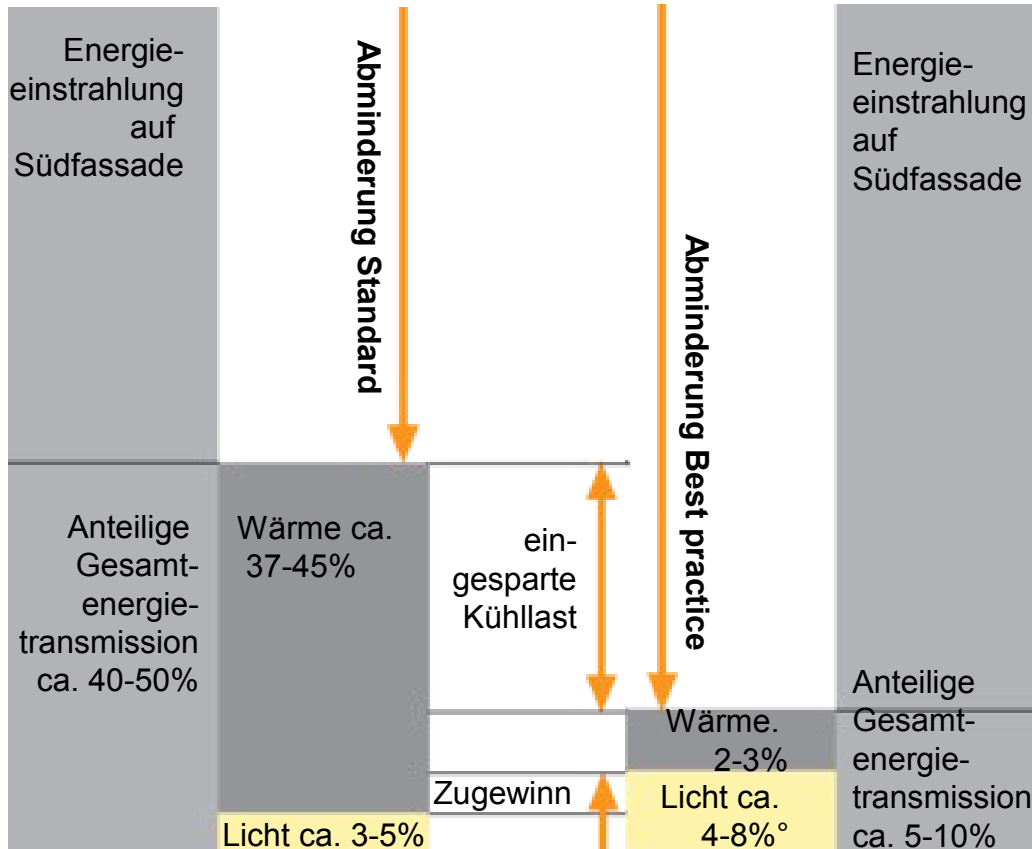

# Optimierungspotentiale

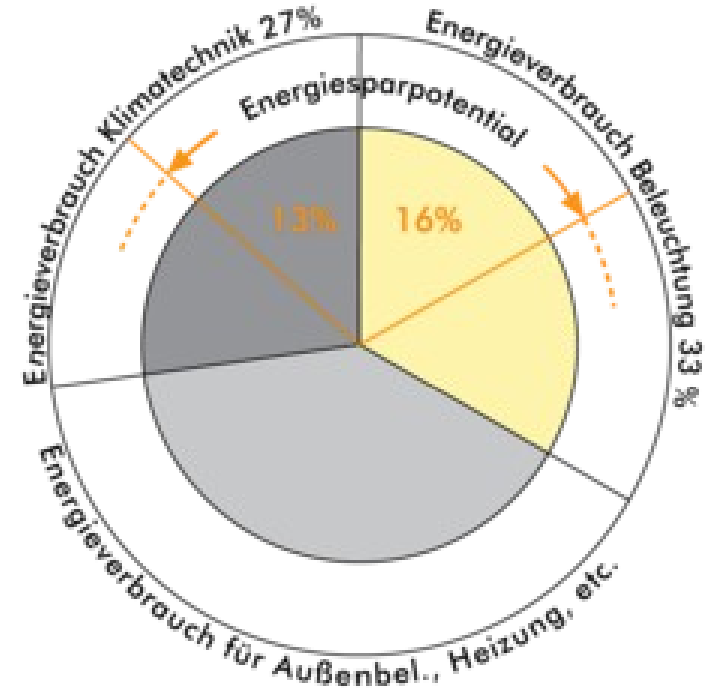

# Zusammenfassung

Was sind die wesentlichen Unterschiede eines Raffstores mit Tageslichtlenkung zu einem üblichen Raffstore?

Welche Vorteile bietet der Raffstore mit Tageslichtlenkung im Vergleich zu einem üblichen Raffstore?

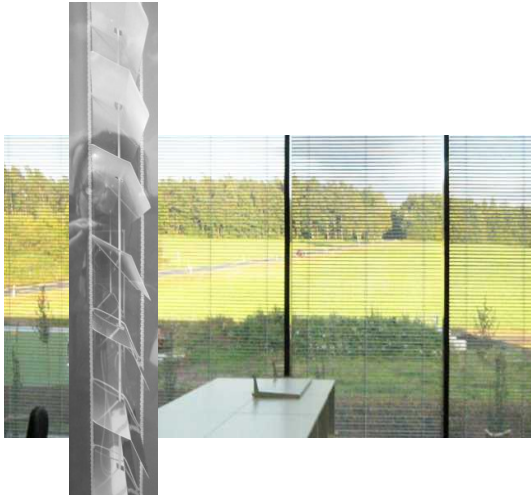

Ohne erhöhtem Wärmeeintrag wird eine bessere Ausleuchtung des Raumes in der Tiefe und eine verbesserte Durchsicht nach Außen erzielt. Der Arbeitsplatz bleibt dabei trotzdem blendfrei.

Der Raffstore mit Tageslichtlenkung fährt in Arbeitsstellung ab (mit geöffnetem Behang) ohne den Raum zu verdunkeln.



Der Behang ist ruhig, ein permanentes Nachführen der Raffstoren ist nicht notwendig.



Der Stromverbrauch für Kunstlicht wird reduziert. Hiermit wird auch die damit verbundene Wärmeentwicklung sowie die Kühllast deutlich reduziert.

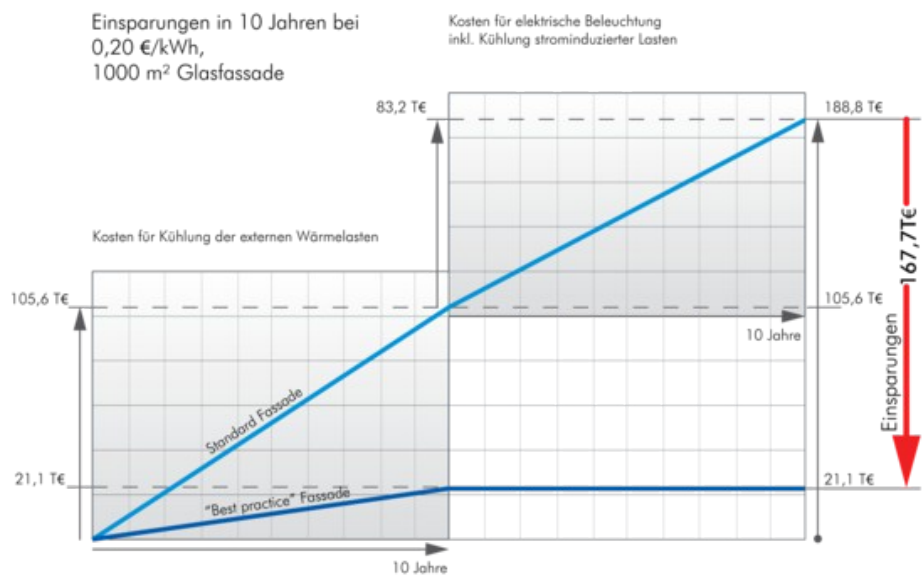



Edward Hopper

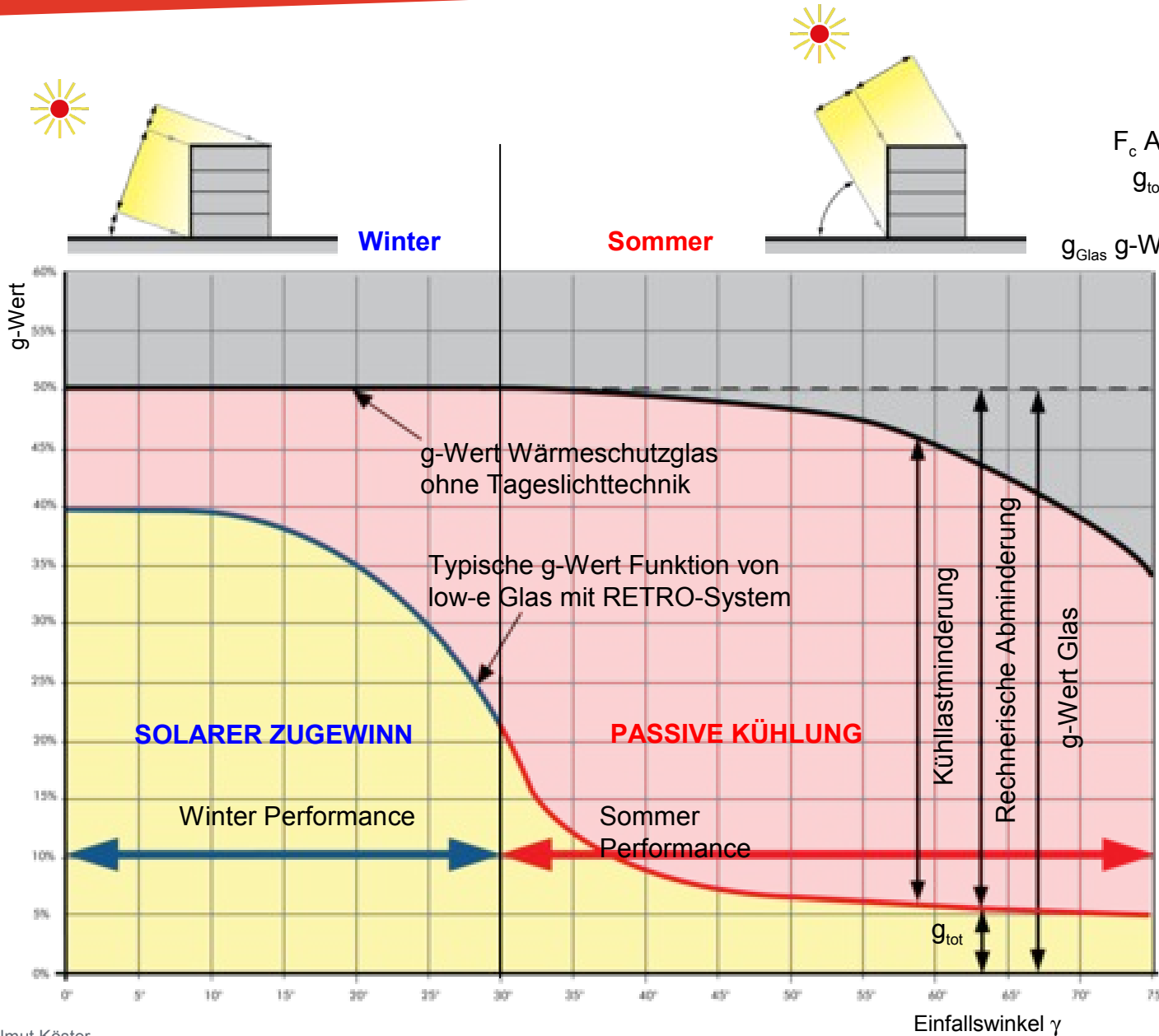

$$F_c = g_{tot} / g_{Glas}$$

$F_c$  Abminderungsfaktor  
 $g_{tot}$  g Verglasung inkl. Lichtlenkung  
 $g_{Glas}$  g-Wert der Verglasung



# Energiekalkulationen

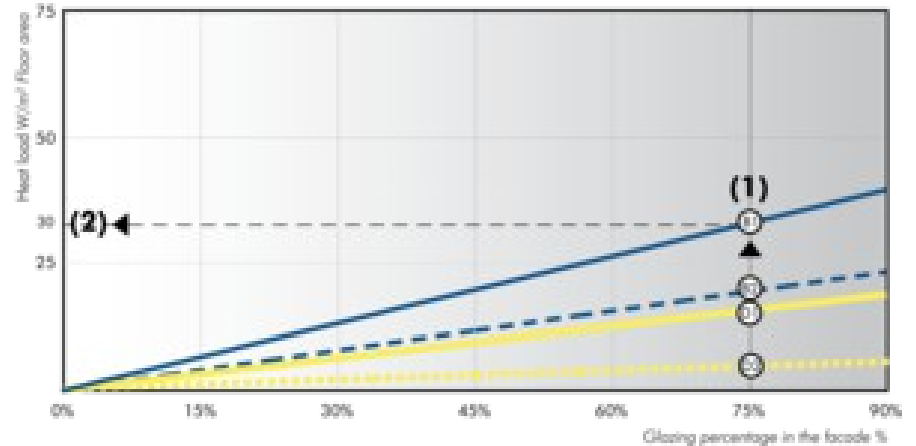
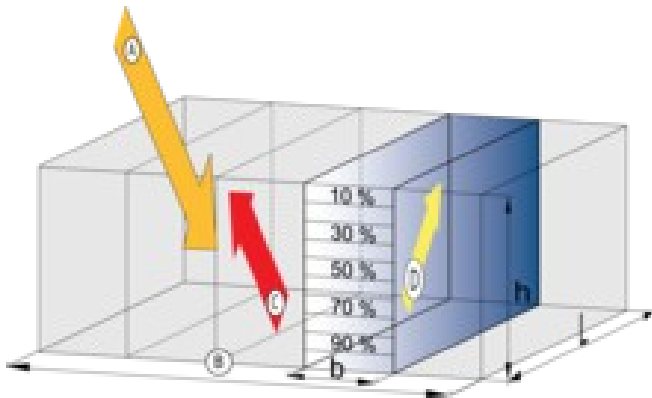
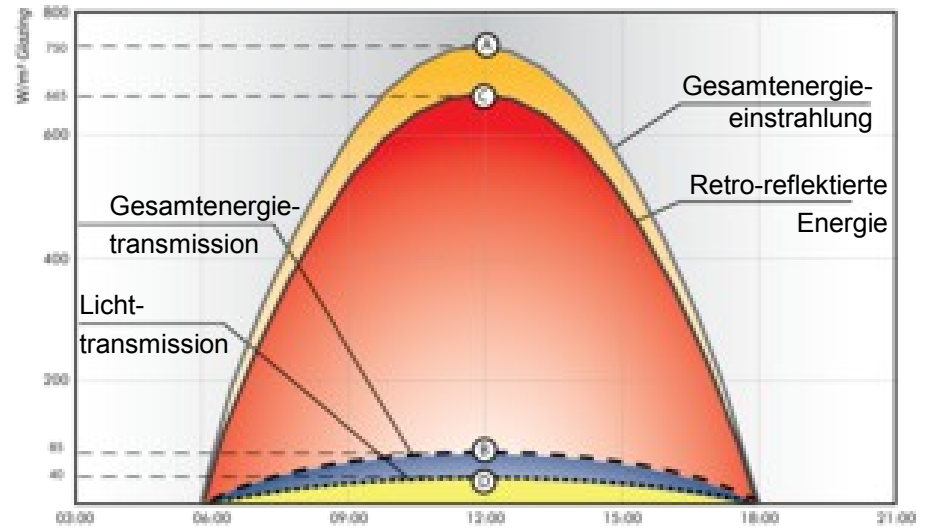
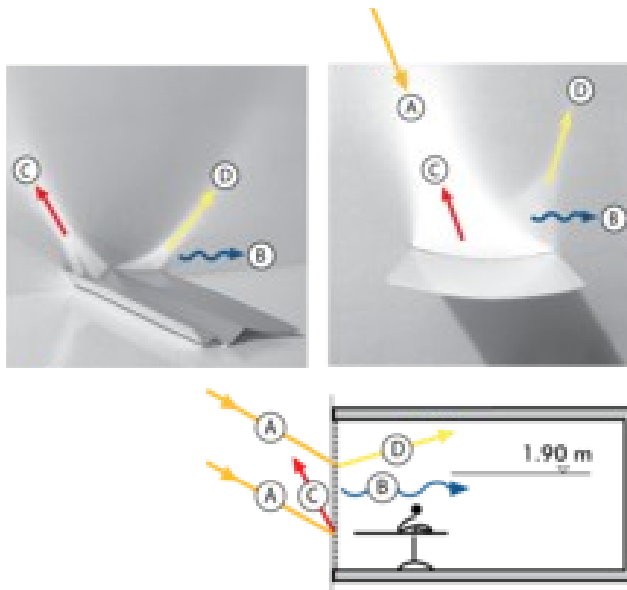

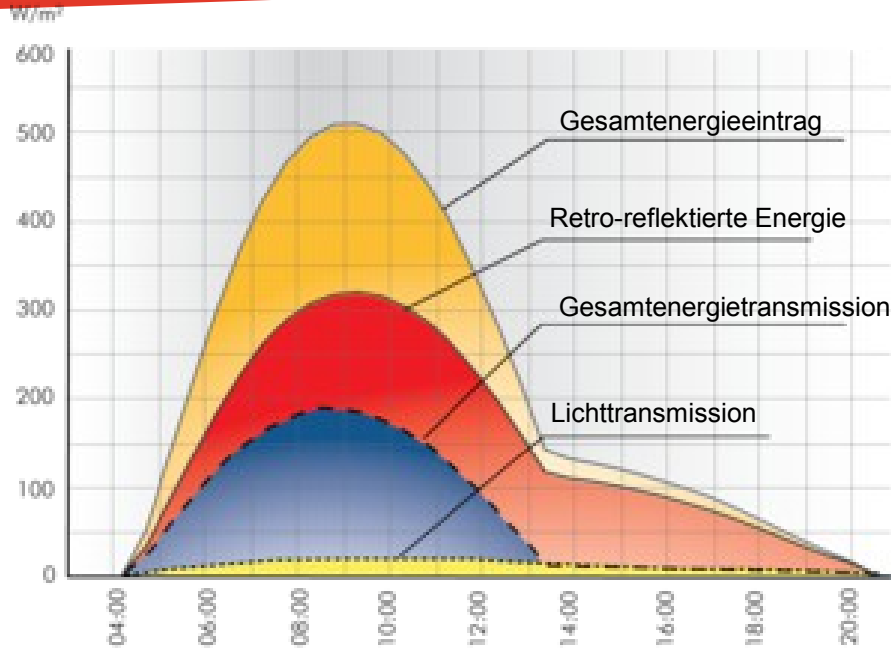

Tageszeitbezogenes  
Energiediagramm

# Energiekalkulationen Standard vs. Best practice

Wärmeschutzverglasung mit  
Standardjalousie, innen, Orient S-O, 21.06.

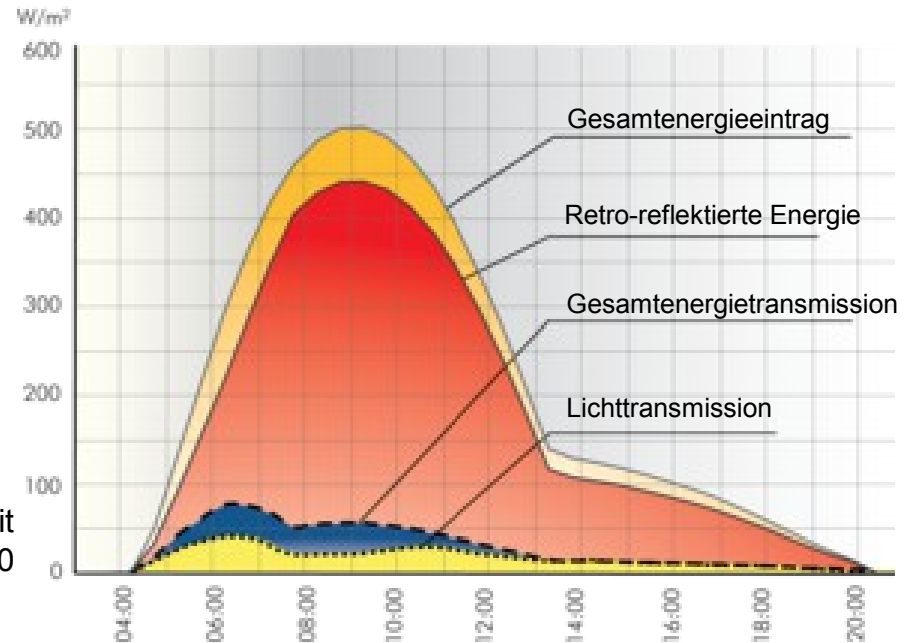

Best practice Fassade mit  
RETROflex 80



Einsparungen in 10 Jahren bei  
0,20 €/kWh,  
1000 m<sup>2</sup> Glasfassade

Kosten für elektrische Beleuchtung  
inkl. Kühlung strominduzierter Lasten

